



Rightangle-Gear



Use and maintenance manual

Manuale uso e manutenzione



Catalogue code: MA-VFM-BS-HM015

HYDRON.ME C

GENERALITY

The gearboxes do not fall within the scope of Machinery Directive 2006/42 / EC, as they are identified as components of the machine.

Article. 35 of the guide to the Machinery Directive states:

"The Machinery Directive does not apply directly to the components of the machines, such as, for example, the speed reducers, which does not have a specific application as such, but are intended to be incorporated in machines, although the design and construction of such components must be such as to make the machine completed in compliance with the relevant requirements and basic safety and health protection. "

Smooth operation and the right to request under guarantee require compliance with the information contained in this manual, which must be read before starting up the group.

The gearboxes, which are not an integral part of a machine properly defined, are not nearly machines, but they are only components, therefore do not fall in the purposes of Machinery Directive 2006/42 / EC.e 2006/42 / EC.

GENERALITA'

I riduttori di velocità non ricadono nel campo d'applicazione della Direttiva Macchine 2006/42/CE, in quanto sono identificati come componenti di macchina.

L'art. 35 della guida alla Direttiva Macchine stabilisce: "La Direttiva Macchine non si applica direttamente ai componenti delle macchine, quali, per esempio i riduttori di velocità, che non hanno un'applicazione specifica in quanto tali, ma sono destinati ad essere incorporati nelle macchine, sebbene la progettazione e la costruzione di detti componenti devono essere tali da rendere la macchina completata conforme ai requisiti pertinenti e fondamentali in materia di sicurezza e di tutela della salute."

Il funzionamento regolare ed il diritto alla richiesta di prestazioni in garanzia richiedono il rispetto delle informazioni contenute nel presente manuale che deve essere letto prima della messa in funzione del gruppo.

I Riduttori, che non sono parte integrante di una macchina propriamente definita, non sono quasi macchine, ma sono solo componenti, pertanto non ricadono negli scopi della Direttiva Macchine 2006/42/CE.

SAFETY

- Written authorization is required to operate or use reducers in man lift or people moving devices.
- Check to make sure that certain applications do not exceed the allowable load capacities published in the current catalog.
- Buyer shall be solely responsible for determining the adequacy of the product for any and all uses to which Buyer shall apply the product. The application by Buyer shall not be subject to any implied warranty of fitness for a particular purpose.
- For safety, Buyer or User should provide protective guards over all shaft extensions and any moving apparatus mounted thereon. The User is responsible for checking all applicable safety codes in his area and providing suitable guards. Failure to do so may result in bodily injury and/or damage to equipment.
- Gearboxes operating in high position should have a protective shield for any possible parts falling down for casual accidents where people are moving under them.
- Hot oil and reducers can cause severe burns. Use extreme care when removing lubrication plugs and vents.
- Make certain that the power supply is disconnected before attempting to service or remove any components. Lock out the power supply and tag it to prevent unexpected application power.
- Reducers are not to be considered fail safe or self-locking devices. If these features are required, a properly sized, independent holding device should be utilized. Reducers should not be used as a brake.
- Any brakes that are used in conjunction with a reducer must be sized or positioned in such a way so as to not subject the reducer to loads beyond the catalog rating.
- Lifting supports including eyebolts are to be used for vertically lifting the gearbox only and not other associated attachments or motors.
- Use of an oil with an EP additive on units with backstops may prevent proper operation of the backstop. Injury to personnel, damage to the reducer or other equipment may result.
- Overhung loads subject shaft bearings and shafts to stress which may cause premature bearing failure and or shaft breakage from bending fatigue, if not sized properly.

SICUREZZA

- E' richiesta autorizzazione scritta per azionare riduttori in ascensori o dispositivi per il movimento delle persone.
- Controllare che alcune applicazioni non eccedano la massima capacità di carico ammessa pubblicata in questo catalogo.
- L'acquirente è l'unico responsabile per la determinazione dell'adeguatezza del prodotto per qualcuna o tutte le utilizzazioni che l'acquirente stesso farà del riduttore. L'applicazione dell'acquirente non potrà essere soggetta ad alcuna implicita garanzia di montaggio per uno scopo particolare.
- Per ragioni di sicurezza l'acquirente dovrà provvedere a porre protezioni adeguate su tutta la lunghezza dell'albero a tutti gli organi in movimento. L'utilizzatore è responsabile del controllo di tutti i codici di sicurezza e la predisposizione di protezioni adeguate. In assenza di tali precauzioni si possono verificare incidenti alle persone e danni agli apparati.
- Su riduttori installati in posizioni elevate utilizzare protezioni adeguate per qualsiasi distacco accidentale di parti nel caso di passaggio di persone al di sotto.
- Olio e riduttori bollenti possono causare gravi ustioni. Usare estrema cautela nella rimozione dei tappi e delle ventole.
- Assicurarsi che la corrente di alimentazione sia scollegata prima di riparare o rimuovere alcun componente. Chiudere l'alimentazione e contrassegnare tale operazione per evitare accensioni accidentali.
- I riduttori non devono essere considerati esenti da guasti o a bloccaggio automatico. Se sono indispensabili queste caratteristiche, deve essere utilizzato un dispositivo indipendente della dimensione adatta. I riduttori non devono essere utilizzati come freni.
- Qualsiasi freno sia utilizzato insieme al riduttore deve essere della giusta grandezza e posizionato in modo da non causare carichi eccessivi non previsti dai dati forniti nel catalogo.
- I dispositivi di sollevamento come le golfare devono essere usati solo per sollevare verticalmente il riduttore e non altri di spositivi associati o motori.
- L'utilizzo di un olio con un additivo EP su gruppi provvisti di dispositivo di arresto possono inficiare l'uso corretto del freno e provocare danni alle persone, alle cose ed al riduttore stesso nonché ad altri apparecchi.
- I Carichi sospesi assoggettano i cuscinetti della vite e la vite stessa a sollecitazioni che possono causare, se non adeguatamente dimensionati, l'usura prematura dei cuscinetti e/o la rottura della vite a causa della resistenza alla flessione.

SAFETY

Gearboxes in this manual are intended for use in industrial applications and meet the standards and regulations that can be adopted.

The performance and specifications are traceable on the nameplate and related documentation.

Transport

Carefully check the status upon receipt and any damage immediately to the carrier.

ASSEMBLY OF PRODUCTS

The following assembly drawings are meant to assist in the search of the main components of the various types of gearbox.

The various designs and dimensions, assembling versions, number of stages, actually generate multiple solutions and therefore we invite you to apply for specific documentation.

SICUREZZA

I riduttori presenti in questo manuale sono rivolti ad uso in applicazioni industriali e corrispondono agli standard e alle regolamentazioni adottabili.

Le prestazioni e i dati tecnici sono rintracciabili sulla targhetta e sulla relativa documentazione .

Trasporto

Verificare con attenzione lo stato al ricevimento e contestare immediatamente eventuali danni al trasportatore.

ASSEMBLAGGIO DEI PRODOTTI

I seguenti disegni di assieme hanno come fine di aiutare nella ricerca dei componenti principali dei vari tipi di riduttore

Le varie forme costruttive e dimensionali, delle versioni di montaggio, del numero di coppie di riduzione, generano in realtà molteplici soluzioni e pertanto si invita a richiedere la documentazione specifica.

SELECTION CHECK LIST

Please Check

EN

I

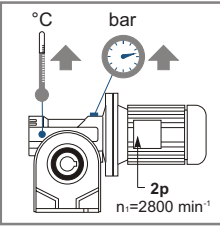
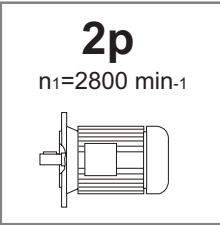
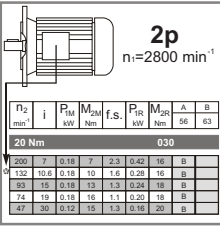
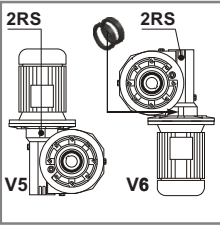
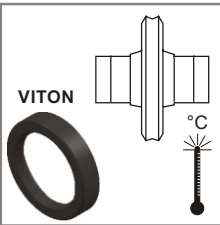
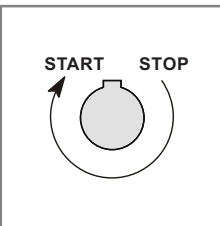
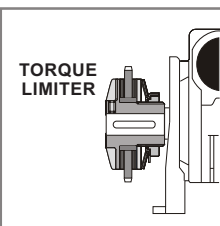
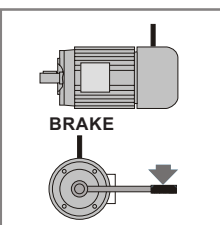
- | <input type="checkbox"/> |  | <p>High speed motors, Higher than 1800 rpm, can produce high operating temperatures within the reducer and should only be used for intermittent duty applications. Decrease the reducer's lubricant levels and install a breather plug.</p> | <p>Nell'utilizzo di motori a 2 Poli durante il funzionamento si possono registrare elevate temperature di funzionamento e pressioni interne. Si consiglia l'uso di tali motori solo per servizi intermittenti. Ridurre il livello di lubrificante ed installare un tappo di sfiato.</p> | | | | | | | | | | | | | | | | | | | | | | | | | | | | | | | | | | | | | | | | | | | | | | | | | | | | | | | | | | | | | | | | | | | | | | | |
|--------------------------|--|--|--|-----------------|-----------------|-----------------|-----------------|-----------------|---|---|-----------------|--|----|----|--|----|----|----|----|--------------|--|------------|--|--|--|--|--|--|-----|---|------|---|-----|------|----|---|--|-----|------|------|----|-----|------|----|---|--|----|----|------|----|-----|------|----|---|--|----|----|------|----|-----|------|----|---|--|----|----|------|----|-----|------|----|---|--|---|
| <input type="checkbox"/> |  | <p>2 poles motors can be used only for very intermittent applications. Specify it in the order to select the most suitable ratios. Please specify in the order if you required a particular level of noise.</p> | <p>Specificare in fase d'ordine se in fase di utilizzo si applica un motore 2 poli.</p> | | | | | | | | | | | | | | | | | | | | | | | | | | | | | | | | | | | | | | | | | | | | | | | | | | | | | | | | | | | | | | | | | | | | | | | |
| <input type="checkbox"/> |  <table border="1" style="font-size: 8px; width: 100%; border-collapse: collapse; margin-top: 5px;"> <thead> <tr> <th>ρ_2</th> <th>i</th> <th>P_{1M}</th> <th>M_{2M}</th> <th>f.s.</th> <th>P_{1R}</th> <th>M_{2R}</th> <th>A</th> <th>S</th> </tr> <tr> <th>mm²</th> <th></th> <th>kW</th> <th>Nm</th> <th></th> <th>kW</th> <th>Nm</th> <th>56</th> <th>63</th> </tr> </thead> <tbody> <tr> <td colspan="2" style="text-align: center;">20 Nm</td> <td colspan="7" style="text-align: center;">030</td> </tr> <tr> <td>200</td> <td>7</td> <td>0.18</td> <td>7</td> <td>2.3</td> <td>0.42</td> <td>16</td> <td>B</td> <td></td> </tr> <tr> <td>132</td> <td>10.8</td> <td>0.18</td> <td>10</td> <td>1.6</td> <td>0.28</td> <td>16</td> <td>B</td> <td></td> </tr> <tr> <td>93</td> <td>15</td> <td>0.18</td> <td>13</td> <td>1.3</td> <td>0.24</td> <td>16</td> <td>B</td> <td></td> </tr> <tr> <td>74</td> <td>19</td> <td>0.18</td> <td>16</td> <td>1.1</td> <td>0.20</td> <td>16</td> <td>B</td> <td></td> </tr> <tr> <td>47</td> <td>30</td> <td>0.12</td> <td>15</td> <td>1.3</td> <td>0.16</td> <td>20</td> <td>B</td> <td></td> </tr> </tbody> </table> | ρ_2 | i | P _{1M} | M _{2M} | f.s. | P _{1R} | M _{2R} | A | S | mm ² | | kW | Nm | | kW | Nm | 56 | 63 | 20 Nm | | 030 | | | | | | | 200 | 7 | 0.18 | 7 | 2.3 | 0.42 | 16 | B | | 132 | 10.8 | 0.18 | 10 | 1.6 | 0.28 | 16 | B | | 93 | 15 | 0.18 | 13 | 1.3 | 0.24 | 16 | B | | 74 | 19 | 0.18 | 16 | 1.1 | 0.20 | 16 | B | | 47 | 30 | 0.12 | 15 | 1.3 | 0.16 | 20 | B | | <p>With 2 poles motor if a particular " low noise" is required ask us the most suitable ratio.</p> <p>Qualora (con il motore a 2 poli) sia richiesta una particolare silenziosità richiedete i rapporti più idonei.</p> |
| ρ_2 | i | P _{1M} | M _{2M} | f.s. | P _{1R} | M _{2R} | A | S | | | | | | | | | | | | | | | | | | | | | | | | | | | | | | | | | | | | | | | | | | | | | | | | | | | | | | | | | | | | | | | | | | |
| mm ² | | kW | Nm | | kW | Nm | 56 | 63 | | | | | | | | | | | | | | | | | | | | | | | | | | | | | | | | | | | | | | | | | | | | | | | | | | | | | | | | | | | | | | | | | | |
| 20 Nm | | 030 | | | | | | | | | | | | | | | | | | | | | | | | | | | | | | | | | | | | | | | | | | | | | | | | | | | | | | | | | | | | | | | | | | | | | | | | |
| 200 | 7 | 0.18 | 7 | 2.3 | 0.42 | 16 | B | | | | | | | | | | | | | | | | | | | | | | | | | | | | | | | | | | | | | | | | | | | | | | | | | | | | | | | | | | | | | | | | | | | |
| 132 | 10.8 | 0.18 | 10 | 1.6 | 0.28 | 16 | B | | | | | | | | | | | | | | | | | | | | | | | | | | | | | | | | | | | | | | | | | | | | | | | | | | | | | | | | | | | | | | | | | | | |
| 93 | 15 | 0.18 | 13 | 1.3 | 0.24 | 16 | B | | | | | | | | | | | | | | | | | | | | | | | | | | | | | | | | | | | | | | | | | | | | | | | | | | | | | | | | | | | | | | | | | | | |
| 74 | 19 | 0.18 | 16 | 1.1 | 0.20 | 16 | B | | | | | | | | | | | | | | | | | | | | | | | | | | | | | | | | | | | | | | | | | | | | | | | | | | | | | | | | | | | | | | | | | | | |
| 47 | 30 | 0.12 | 15 | 1.3 | 0.16 | 20 | B | | | | | | | | | | | | | | | | | | | | | | | | | | | | | | | | | | | | | | | | | | | | | | | | | | | | | | | | | | | | | | | | | | | |
| <input type="checkbox"/> |  | <p>Please specify when ordering if reducer are used in Vertical V5 or V6 mounting position. We normally mount a 2RS self lubricated bearings (see picture) for V6 mounting we recommend double oil seals in the input side V6 positions is not recommended for 2 poles motors</p> | <p>Specificare in fase d'ordine se i riduttori richiesti vengono utilizzati per posizioni di montaggio verticali V5÷V6. Per queste posizioni va previsto un cuscinetto schermato 2RS come in figura. Per montaggio V6 suggeriamo l'uso di 2 anelli di tenuta in entrata. V6 (Posizione sconsigliata con motori 2 Poli).</p> | | | | | | | | | | | | | | | | | | | | | | | | | | | | | | | | | | | | | | | | | | | | | | | | | | | | | | | | | | | | | | | | | | | | | | | |
| <input type="checkbox"/> |  | <p>In case of high temperatures we suggest to use FPM (fkm) Oil seals in the output shaft.</p> | <p>In caso di temperature elevate consigliamo di montare anelli di tenuta in FPM (fkm) sul mozzo.</p> | | | | | | | | | | | | | | | | | | | | | | | | | | | | | | | | | | | | | | | | | | | | | | | | | | | | | | | | | | | | | | | | | | | | | | | |
| <input type="checkbox"/> |  | <p>For applications having frequent starts and stops it is recommended to use two oil seals or double lip oil seals to avoid premature wear of the oil seals.</p> | <p>Per applicazioni con un numero elevato di avviamenti / arresti è consigliabile montare due anelli di tenuta (063+085) sull'albero di uscita.</p> | | | | | | | | | | | | | | | | | | | | | | | | | | | | | | | | | | | | | | | | | | | | | | | | | | | | | | | | | | | | | | | | | | | | | | | |
| <input type="checkbox"/> |  | <p>If the application is with high shock loads and sudden stops it's suggested to use mechanical or electronic torque limiting devices.</p> | <p>Se nell'applicazione si prevedono sovraccarichi prolungati, urti o bloccaggi improvvisi, installare sistemi meccanici o elettronici di limitazione della coppia.</p> | | | | | | | | | | | | | | | | | | | | | | | | | | | | | | | | | | | | | | | | | | | | | | | | | | | | | | | | | | | | | | | | | | | | | | | |
| <input type="checkbox"/> |  | <p>Reducers are not to be considered fail safe or self-locking devices. If these features are required, a properly sized, independent holding device should be used. Reducers should not be used as a brake. Any brakes that are used in conjunction with a reducer must be sized or positioned in such a way so as to not subject the reducer to loads beyond the catalog rating.</p> | <p>Segnalare se l'utilizzo è con motore autofrenante con elevati numeri di manovra. Nelle installazioni accertarsi che la coppia generata dal l'inerzia del carico in fase di frenatura non superi i limiti del riduttore; verificare (con chiave dinamometrica) che la coppia di taratura del freno corrisponda ai dati convalidati dal progetto.</p> | | | | | | | | | | | | | | | | | | | | | | | | | | | | | | | | | | | | | | | | | | | | | | | | | | | | | | | | | | | | | | | | | | | | | | | |

SELECTION CHECK LIST



Please Check

EN

I

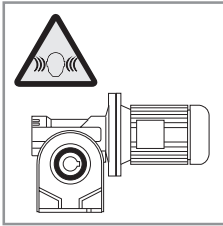

Specify when ordering if you require particular low noise level.

Segnalare in fase d'ordine se sono richiesti particolari livelli di rumorosità.

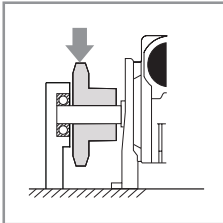

For very heavy radial load, additional output shaft support may be required to prevent premature bearing failure or shaft breakage from bending fatigue.

In applicazioni con un carico radiale molto elevato si consiglia di prevedere un supporto supplementare sull'albero per impedire l'usura prematura del cuscinetto o la rottura dell'albero.



It's compulsory to request HYDRO-MEC authorization to use our gearboxes when the units are used in a man lift or people moving devices.

E' obbligatorio richiedere in fase d'ordine la autorizzazione scritta per usare i nostri riduttori in applicazioni che possono coinvolgere delle persone.

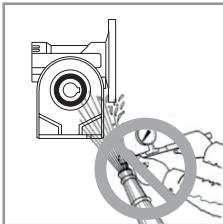

Please do not clean oil seals with high pressure water directly or seals may loose after short time.

Si prega di non pulire direttamente anelli di tenuta e guarnizioni con acqua ad alta pressione, in tal caso il riduttore potrebbe perdere dopo poco tempo.

INSTALLATION CHECK LIST

Please Check

EN

I

Installation
Installazione

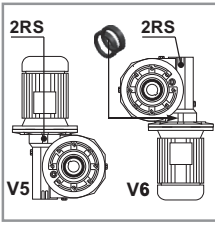
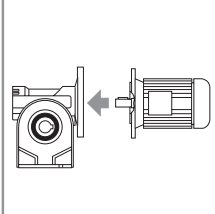
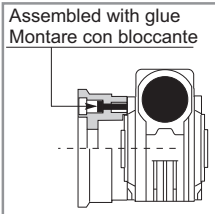
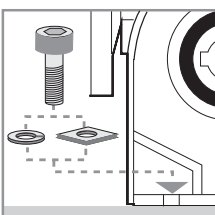
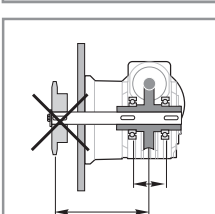
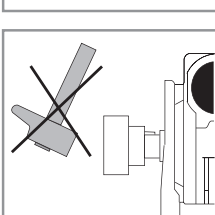
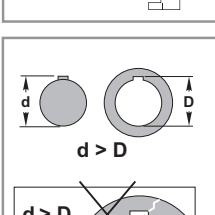
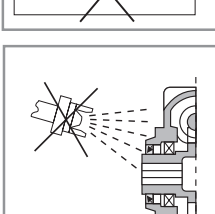

<input type="checkbox"/>		<p>Do not change mounting positions without contacting our factory. Altering the mounting position may require special lubrication provisions which must be installed from the factory. When reducers are mounted in positions V5 or V6 and used in continuous duty applications, replace the upper bearing with a self lubricated style bearing, and we suggest double input seal for V6.</p>	<p>Specificare in fase d'ordine se i riduttori devono essere forniti per posizioni di montaggio V5+V6 per prevedere eventuali cuscinetti 2RS (schermati), ed eventuali anelli di tenuta agiuntivi. Per la posizione V6 è consigliato usare 2 anelli di tenuta. (posizione non adatta per motori 2 poli)</p>
<input type="checkbox"/>		<p>When mounting a motor to reducers, the fastening bolts should not be tightened until both the reducer flange and motor face are in contact. When mounting is complete check by manually rotating the fan to be sure the assembly turns freely.</p>	<p>L'accoppiamento al motore deve essere libero e scorrevole. Il serraggio delle viti di fissaggio deve essere effettuato solo quando le due flange saranno a contatto. Ad assemblaggio avvenuto controllare che il motore ruoti liberamente agendo manualmente sulla ventola.</p>
<input type="checkbox"/>	<p>Assembled with glue Montare con bloccante</p> 	<p>In applications where multiple starts, stops or reverses occurs, it is recommended to block the fastening bolts of the output flange and feet.</p>	<p>In applicazioni caratterizzate da numerosi avviamenti/arresti o inversioni, è consigliabile bloccare le viti di fissaggio delle flange.</p>
<input type="checkbox"/>		<p>Mount the reducer on a flat surface free of vibration. If high over hung loads are expected, it is advisable to reinforced bolt heads with washers as shown in picture.</p>	<p>Assicurarsi che il fissaggio del riduttore sia effettuato su un basamento rigido, in piano e non soggetto a vibrazioni. Se si prevedono elevate sollecitazioni utilizzare rosette spaccate sotto la testa delle viti di fissaggio al basamento.</p>
<input type="checkbox"/>		<p>Make sure that mounting of pulleys or pinions does not create over hung loads exceeding the capacity of the reducer.</p>	<p>Accertarsi che l'eventuale montaggio di pignoni o pulegge a sbalzo su gli alberi sia stato convalidato da precedenti verifiche di ammissibilità dei carichi risultanti.</p>
<input type="checkbox"/>		<p>When mounting pinions, pulleys or couplings on the reducer's shaft, protect the bearings from impact by using the appropriate pullers and threaded holes in the end of the reducer shaft.</p>	<p>Nel montaggio di pignoni, giunti o pulegge sugli alberi del riduttore evitare urti facendo uso di appropriati estrattori ancorati nei fori filettati presenti all'estremità degli alberi stessi.</p>
<input type="checkbox"/>	 <p style="text-align: center;">$d > D$</p>	<p>When mounting items to the reducer shaft, appropriate anti-seize and oxidizer compounds should be used, and keys dimensions are correct.</p>	<p>In tutti gli accoppiamenti albero/mozzo spalmare le superfici a contatto con adeguati protettivi antiossidazione e verificare che le linguette non siano forzate onde evitare la rottura del mozzo.</p>
<input type="checkbox"/>		<p>If the reducer is to be painted, protect machined surfaces and oil seals from over-spray.</p>	<p>Durante l'eventuale verniciatura proteggere gli anelli di tenuta e i piani lavorati.</p>

INSTALLATION CHECK LIST

Please Check

EN

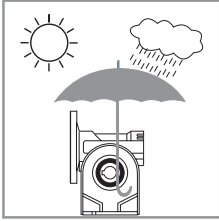
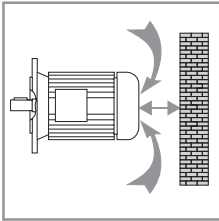
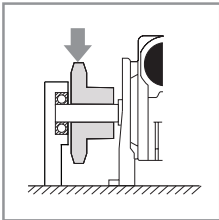
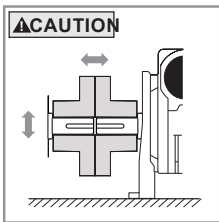
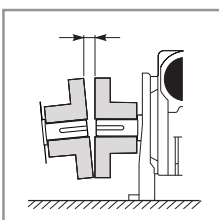
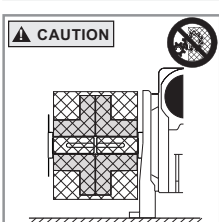
I

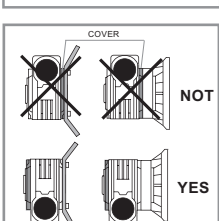
<input type="checkbox"/>		<p>When installed out doors, make sure protection is provided from atmospheric elements.</p>	<p>Per riduttori installati all'esterno prevedere opportune protezioni contro gli agenti atmosferici e l'irraggiamento diretto. Per installazioni in ambienti umidi adottare adeguate protezioni sulle superfici lavorate del riduttore.</p>
<input type="checkbox"/>		<p>Make sure there is sufficient space between any obstructions and the motor's air intake area to provide adequate cooling for the motor.</p>	<p>Lasciare fra il copriventola del motore e l'eventuale parete uno spazio sufficiente a garantire il passaggio dell'aria di raffreddamento.</p>
<input type="checkbox"/>		<p>For very heavy radial load, additional output shaft support may be required to prevent premature bearing failure or shaft breakage from bending fatigue.</p>	<p>In applicazioni con un carico radiale molto elevato si consiglia di prevedere un supporto supplementare sull'albero.</p>
<input type="checkbox"/>	<p>CAUTION</p> 	<p>The system of connected rotating parts must be free from critical speed, torsional or other type vibration, no matter how induced. The responsibility for this system analysis lies with the purchaser of the speed reducer.</p>	<p>Il collegamento delle parti in rotazione deve essere esente da qualsiasi tipo di torsione o di vibrazione dovuta alla velocità.</p>
<input type="checkbox"/>		<p>Check shaft and coupling alignment. Check proper coupling gap before to lock all foundation bolts that should be routinely checked.</p>	<p>Si consiglia di controllare l'allineamento delle parti in rotazione (collegamenti, alberi etc.) prima della messa in funzione del riduttore e periodicamente controllare il fissaggio dei bulloni di collegamento.</p>
<input type="checkbox"/>	<p>CAUTION</p> 	<p>For safety, Buyer or User should provide protective guards over all shaft extensions and any moving apparatus mounted thereon. The User is responsible for checking all applicable safety codes in his area and providing suitable guards. Failure to do so may result in bodily injury and/or damage to equipment.</p>	<p>Per la sicurezza, il compratore o l'utente dovrebbero prevedere delle protezioni sopra tutti gli alberi e tutti gli apparecchi messi in rotazione montati sul riduttore.</p>
<input type="checkbox"/>	<p>CHECK!</p> 	<p>Test run the first unit to verify proper operation.</p>	<p>Si consiglia di eseguire un check-up di prova prima della messa in funzione per assicurare un funzionamento adeguato, controllando la Potenza Assorbita.</p>
<input type="checkbox"/>	<p>COVER</p> 	<p>In case of high loads do not fix the gearbox on its side cover (FB). It is recommended infact to use the opposite side as, in such a way, the gearbox fixing is carried out directly on the housing in a safer way.</p>	<p>In applicazioni con presenza di sovraccarichi non è consigliabile fissare il riduttore sul coperchio laterale. E' preferibile utilizzare il lato opposto al coperchio perchè il fissaggio viene effettuato di rettamente sulla cassa in modo più rigido.</p>

**Maintenance
Manutenzione**

Gearboxes that are lubricated for life do not require any maintenance.

For others, the lubricant needs to be periodically refilled and eventually changed with a suitable grade.

Avoid mixing synthetic and mineral lubricants.

It is advisable to carry out the first mineral oil change after 150 operating hours and the subsequent ones every 4000 operating hours.

From time to time check that the fan cowl is not clogged with dust or fibres.

For brake motors it is also necessary to periodically check the air gap and replace the brake lining if the values exceed permissible ones.

Also check the brake torque using a torque meter.

I riduttori lubrificati a vita non necessitano di manutenzione. Per gli altri è necessario effettuare una verifica periodica del livello dell'olio eventualmente ripristinandolo con un tipo compatibile.

Evitare di mescolare olii sintetici con olii minerali.

Effettuare il primo cambio dell'olio minerale dopo 150 ore e i successivi dopo 4000 ore di funzionamento. Verificare che la griglia posteriore del motore non sia ostruita da polvere, filamenti o altro.

Nei motori autofrenanti controllare periodicamente il valore del traferro effettuando la sostituzione del ferodo se i valori sono superiori a quelli ammessi. Verificare la coppia frenante con chiave dinamometrica.

**Stocking
Stoccaggio**

In order to safeguard the efficiency of the gearboxes, it is required to observe the following indications:

- stock the gearboxes in appropriate environments with a low humidity level
- Place the same possibly onto shelves
- In case of prolonged stocking periods, lubricate the external parts which could be subject to oxidation (shafts and machined parts).

The non lubricated gearboxes should be completely filled up with oil. Oil level should then be reset to required levels during installation.

Per garantire l'efficienza dei riduttori ricevuti, è necessario osservare le seguenti indicazioni:

- conservarli in ambienti riparati con un basso livello di umidità
- disporli su scaffali o piani
- per periodi di stoccaggio prolungati, lubrificare con grasso le parti esterne che potrebbero essere soggette ad ossidazione (alberi e piani lavorati).

Per i riduttori forniti privi di lubrificante è consigliabile riempirli completamente di olio ripristinandone ovviamente il livello corretto durante l'installazione.

**Supply terms
Condizioni di fornitura**

Gearboxes are supplied as follows:

- prearranged to be installed in the ordered mounting position
- tested as per internal specifications
- with appropriate packing
- coupling surfaces not painted
- without nuts and bolts for motor mounting as per IEC version
- already filled in with lubricant where specified
- already painted where specified
- already equipped with lifting eyebolts

I riduttori vengono forniti come segue:

- già predisposti per essere installati nella posizione di montaggio come definito in fase di ordine
- collaudati secondo specifiche interne
- appositamente imballati
- le superfici di accoppiamento non sono verniciate
- sprovvisti di dadi e bulloni per montaggio motori per la versione IEC
- già provvisti di lubrificante (dove previsto)
- già verniciati (dove previsto)
- già provvisti di golfare di sollevamento (dove previsto)

For a proper selection of the required gearbox it is important to follow the following table:

Per una corretta selezione del riduttore o motoriduttore è importante rispettare le seguenti indicazioni:

Service factor
Fattore di servizio

1 Find out the application service factor through the following table.

Determinare tramite la seguente tabella il fattore di servizio **fs** relativo all'applicazione.

Type of load and starts per hour Tipo di carico e avviamenti per ora		fs			
		Oper. hours per day Ore di funz. giorn.			
		<2 h	2 - 8 h	8 - 16 h	
Continuous or intermittent appl. with start/hour Applicazione cont. o interm. con n.ro operazioni/ora	≤ 10	Uniform / Uniforme	0.9	1	1.25
		Moderate / Moderato	1	1.25	1.5
		Heavy / Forte	1.25	1.5	1.75
Intermittent application with start/hour Applicazione intermittente con n.ro operazioni/ora	> 10	Uniform / Uniforme	1.25	1.5	1.75
		Moderate / Moderato	1.5	1.75	2
		Heavy / Forte	1.75	2	2.25

N.B. For applications with flameproof motors or instantaneous reversal, multiply the service coefficient by 1.15.

N.B. Per azionamenti con motore a scoppio o per funzionamento alternato istantaneo, moltiplicare il valore del coefficiente di servizio per 1.15.

Gearbox selection
Scelta di un riduttore

2 A gear box version R (or B) is to be found from the selection tables, considering the required power P_{1R} (or torque M_{2R} required) and output speed n_2 referred to 1400 min^{-1} (or to gearbox ratio).
Once the gearbox has been chosen, P_{1R} power and n_1 speed (given in the table), it should comply with the following conditions:

Un riduttore nella configurazione R (o B) dovrà essere ricercato nelle tabelle di selezione riduttori in base alla potenza richiesta P_{1R} (o alla coppia richiesta M_{2R}) e ai giri uscita n_2 riferiti a 1400 min^{-1} (o al rapporto di trasmissione i).
Il riduttore selezionato in base alla potenza P_{1R} (indicata in tabella) e a n_1 dovrà soddisfare le seguenti condizioni:

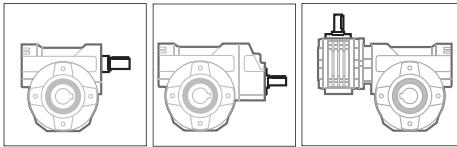

2 Poles
2 Poli



$$n_1 = 1400 \text{ min}^{-1}$$

$$P_{1R} \geq P_{1r} \times fs$$

$$n_1 = 2800 \text{ min}^{-1}$$

$$P_{1R} \times 1.6 \geq P_{1r} \times fs$$

Where 2 pole motors are required, specify when placing order to foresee lubricant and synthetic oil.

Per l'abbinamento a motori a 2800 min^{-1} , specificare sempre tale caratteristica in fase di ordine per prevedere lubrificante e olio sintetici co.

6 Poles
6 Poli



$$n_1 = 900 \text{ min}^{-1}$$

$$P_{1R} / 1.5 \geq P_{1r} \times fs$$

Following symbols will be found in the selection tables of the gearboxes:

Alle tabelle di selezione dei riduttori è associata la seguente simbologia:

n_2 [min ⁻¹]	i	P_{1M} [kW]	M_{2M} [Nm]	f.s.	P_{1R} [kW]	M_{2R} [Nm]
-------------------------------	---	------------------	------------------	------	------------------	------------------

- n_2 [min⁻¹] output speed ($n_1 = 1400 \text{ min}^{-1}$)
- i — reduction ratio
- P_{1M} [kW] motor input power ($n_1 = 1400 \text{ min}^{-1}$)
- M_{2M} [Nm] output torque ($n_1 = 1400 \text{ min}^{-1}$)
- P_{1R} [kW] Transmitted power at input gearbox
- M_{2R} [Nm] Transmitted output torque
- RD — Dynamic efficiency
- Mn — Tooth normal module

- n_2 [min⁻¹] giri in uscita ($n_1 = 1400 \text{ min}^{-1}$)
- i — rapporto di riduzione
- P_{1M} [kW] potenza nominale motore ($n_1 = 1400 \text{ min}^{-1}$)
- M_{2M} [Nm] coppia in uscita ($n_1 = 1400 \text{ min}^{-1}$)
- P_{1R} [kW] potenza trasmessa in entrata
- M_{2R} [Nm] coppia trasmessa in uscita
- RD — rendimento dinamico
- Mn — modulo normale del dente

20 Nm

200	7	0.18	7	2.3	0.42	16
132	10.6	0.18	10	1.6	0.28	16
93	15	0.18	13	1.3	0.24	18
74	19	0.18	16	1.1	0.20	18
47	30	0.12	15	1.3	0.16	20

SELECTION GUIDE / GUIDA ALLA SELEZIONE

EN

I

3 Selection tables can be used also for the mounting version P (With IEC B5 - B14 motor flange).

In this case, besides carrying out all previous cheques, it is also necessary to verify the availability of the required motors (56, 63, 71, etc.) in the shaded columns. Associated symbols are the following:

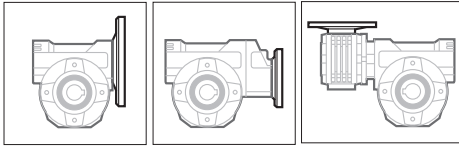

Le tabelle per la selezione riduttori possono essere utilizzate anche per i riduttori nella configurazione P (predisposti per attacco motore IEC B5 o B14).

Oltre alle verifiche precedentemente illustrate è necessario controllare, nelle colonne retinate, l'applicabilità della grandezza (56, 63, 71, ecc.) del motore desiderato. La simbologia aggiuntiva associata è la seguente:

B5							B14					
A	B	C	D	E	F	G	O	P	Q	R	T	U
56	63	71	80	90	100 112	132	56	63	71	80	90	100 112

B							B-C					
B							B-C					
B							B-C					
B							B-C					

56... — suitable motor sizes (IEC)

B5 — B5 motorflange

B14 — B14 motorflange

— available motor adaptors

B — assembling by means of reduction bushes 

C — motor flange/terminal box position 

B — available without reduction bushes

56... — grandezze motore (IEC) applicabili

B5 — predisposizione flange B5

B14 — predisposizione flange B14

— grandezze motore accoppiabili

B — montaggio con boccola di riduzione 

C — posizione fori flangia/basetta motore 

B — disponibile anche senza boccola

Selection of a motorized gearbox Scelta di un motoriduttore

4 Motorized gear boxes (version M) can be easily selected throughout the appropriate selection tables.

Knowing P_1 value, in corresponding to the required output speed, the gearbox should be selected having a service factor equal or higher than the one shown in point 1. In addition to 4 pole motors (1400 min^{-1}) it is also possible to select 6 pole (900 min^{-1}) motors.

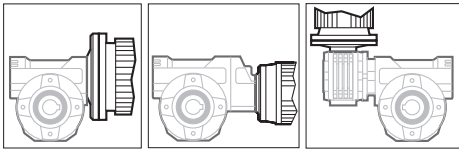





I motoriduttori (configurazione M) possono essere selezionati agevolmente tramite le tabelle di selezione motoriduttori.

Conoscendo P_1 , in corrispondenza del numero di giri in uscita n_2 desiderato, si sceglierà il motoriduttore il cui fattore di servizio f_s sia uguale o maggiore a quello definito al punto 1.

Oltre alle motorizzazioni con motori a 4 poli (1400 min^{-1}) è possibile selezionare (dove disponibili) motori a 6 poli (900 min^{-1}).

$P_1 = 0.13 \text{ kW}$

$n_1 = 1400 \text{ min}^{-1}$ (63A4) - 900 min^{-1} (63B6)

n_2 [min^{-1}]	M_2 [Nm]	i	f_s	M_n					IEC		 Dimensions on page
									B5	B14	
0.30	952	3000	0.9	5.6			115	63B6	63B)-71	56 ^{B)(C)} -63 ^{B)(C)} -71	
0.44	788	2040	1.1	5.6			115	63B6	63B)-71	56 ^{B)(C)} -63 ^{B)(C)} -71	
0.47	692	3000	1.2	5.6			115	63A4	63B)-71	56 ^{B)(C)} -63 ^{B)(C)} -71	
0.58	596	2400	1.4	5.6			115	63A4	63B)-71	56 ^{B)(C)} -63 ^{B)(C)} -71	

Following symbols are associated to the selection tables of the geared motors:

P_1 [kW] potenza in entrata ($n_1 = 1400 \text{ min}^{-1}$)

n_2 [min^{-1}] giri in uscita ($n_1 = 1400 \text{ min}^{-1}$)

M_2 [Nm] coppia trasmessa in uscita

i — rapporto di riduzione

f_s — fattore di servizio

B5 — predisposizione flange B5

B14 — predisposizione flange B14

B) — montaggio con boccola di riduzione 

C) — posizione fori flangia/basetta motore 

 flange attacco motore IEC disponibili

Alle tabelle di selezione dei motoriduttori è associata la seguente simbologia:

P_1 [kW] input power ($n_1 = 1400 \text{ min}^{-1}$)

n_2 [min^{-1}] output speed ($n_1 = 1400 \text{ min}^{-1}$)

M_2 [Nm] transmitted output torque

i — reduction ratio

f_s — service factor

B5 — B5 motorflange

B14 — B14 motorflange

B) — mounting with reduction ring 

C) — motor flange/terminal box position 

 suitable motorflanges IEC

An easier selection of the motorized gearbox (closer as possible to sf 1) can be done through our gear selection table (Point 2). In fact only 4 pole motors (1400 min⁻¹) are listed here .

Una selezione semplificata del motoriduttore in base ad un unico fattore di servizio (il più prossimo a 1) può essere effettuata tramite le tabelle di selezione riduttori (punto 2). In questo caso sono riportati solo motoriduttori con motori a 4 poli (1400 min⁻¹).

Gearbox coupled to a speed variator
Riduttore con variatore di velocità

- 5** Where a hydraulic or mechanic variator is connect to a gearbox, it is necessary to consider if there is a low output speed, when the input speed is decreasing, M_2 torques can easily exceed their nominal values. In high reduction ratios this effect should be taken even in more consideration.

Qualora al riduttore venga abbinato un variatore idraulico o meccanico, è necessario considerare che a bassi giri, al diminuire della velocità d'ingresso, le coppie M_2 possono superare anche notevolmente il valore nominale. Tale effetto deve essere maggiormente tenuto in considerazione nei rapporti elevati.

Gearbox equipped with a brake motor
Riduttore con motore autofrenante

- 6** For selection with brake motors, make sure that the torque generated by the load inertia during braking does not exceed the gearbox limits; check (with the appropriate torque meter) that brake torque matches the data given in the project.

Nella selezione con motori autofrenanti, potendo essere considerevole l'effetto inerziale delle masse, è opportuno scegliere riduttori con $f_s \geq 1$.

Selections not listed in the catalogue
Selezioni fuori catalogo

- 7** In cases where higher powers than the ones given in this catalogue have to be used, our factory cannot guarantee the proper operation of the gearbox.

Nel caso vengano applicate potenze superiori a quelle indicate a catalogo, la nostra ditta non può garantire il corretto funzionamento del gruppo.

Notes
Note

- 8** It is necessary to refer the following the applications to our technical service.
- Applications where gearbox failure is critical.
 - Applications with particularly high inertias
 - Lifting devices.
 - High dynamic stress on gearbox housing.
 - Particular environment conditions with temperatures lower than 5°C or higher than 40°C.
 - Highly chemical aggressive environment.
 - Salty environment.
 - Applications not considered in the catalogue.
 - Radioactive environment.
 - Pressure different to atmospheric.
 - Avoid those applications where total or partial immersion of the gearbox is required.

Occorre tenere nella giusta considerazione e valutare attentamente le segg. applicazioni consultando il ns. Servizio Tecnico.

- Utilizzo in servizi che potrebbero risultare pericolosi per l'uomo in caso di rottura del riduttore.
- Applicazioni con inerzie particolarmente elevate.
- Utilizzo come organo di sollevamento.
- Applicazioni con elevate sollecitazioni dinamiche sulla cassa del riduttore.
- Utilizzo in ambiente con temperatura inferiore a 5°C o superiore a 40°C.
- Utilizzo in ambiente con presenza di aggressivi chimici.
- Utilizzo in ambiente salmastro.
- Posizioni di piazzamento non previste a catalogo.
- Utilizzo in ambiente radioattivo.
- Utilizzo in ambiente con pressione diversa da quella atmosferica.
- Evitare applicazioni dove è prevista l'immersione, anche parziale, del riduttore.

**Thermal limit
Limite termico**

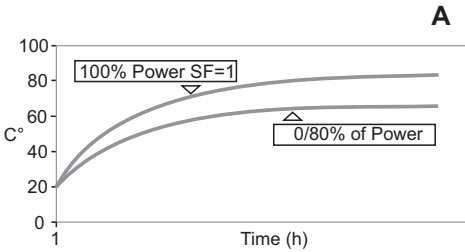

Worm gearboxes, because of their inside design, transform part of their installed power into heat which is subsequently disposed of throughout the housing and may result into values, measured onto the gear case in the area of the worm shaft, in the range of 80 - 100 °C without this affecting the operation of the gear unit adversely.

The diagram of the temperature increase depending on the operating time is illustrated in graph A. Final temperature is given by the sum of several components :

- Installed power and percentage of usage
- Ambient temperature
- Lubrication
- Cooling method
- Input speed

I riduttori a vite senza fine, dato lo schema costruttivo, trasformano parte della potenza installata in calore che viene smaltito dalla carcassa e in corrispondenza della vite senza fine può raggiungere valori misurati nell'intorno di 80 - 100 °C senza che questo pregiudichi la meccanica del riduttore.

Il diagramma dell'incremento della temperature in funzione del tempo di funzionamento è illustrato nel grafico A.

La temperatura finale raggiunta è data dalla somma di varie componenti:

- Potenza installata e percentuale di utilizzo
- Temperatura ambiente
- Tipo di lubrificazione
- Tipo di raffreddamento
- Velocità in ingresso

**Thermal limit with intermittent duty
Limite termico per funzionamento intermittente**

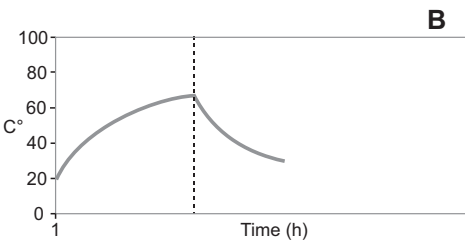

In this case the temperature increase curve is similar to the one for continuous duty. In fact the peak is reached in approximately 20/30 minutes using 100% of the power.

The gearbox can be stopped at any point of this curve then following a cooling curve whose shape depends on the ambient temperature (graph B).

In questo caso la curva di aumento temperatura è simile a quella del funzionamento continuo e normalmente viene raggiunto il valore massimo in 20/30 minuti circa e con il 100% della potenza utilizzata.

In qualsiasi punto di tale curva venga quindi a fermarsi il riduttore, si crea una curva di raffreddamento che è più o meno rapida a seconda della temperatura ambiente (grafico B).

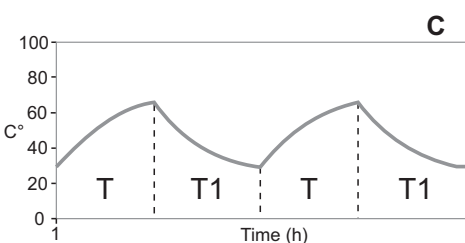

Should the gearbox have several starts and stops cycles, the final temperature depends on starts and stops times (very similar to electric motors with operation S3 and S6 see graphs C and D).

Service factor values indicated in this catalogue refer to an intermittent duty.

Se il riduttore ha poi cicli di arresti ed avviamenti, la temperatura finale dipende dal tempo di arresto e di funzionamento (con un comportamento molto simile a quello dei motori elettrici con funzionamento S3 o S6, vedi grafici C e D).

I valori del fattore di servizio $f_s=1$ riportati in questo catalogo si riferiscono ad un tipo di funzionamento intermittente.

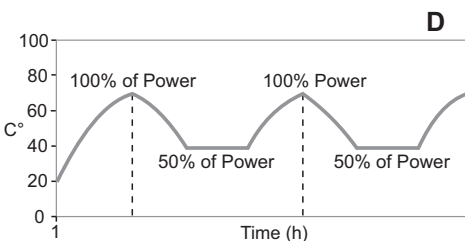

Geared motor selections with 2800 min⁻¹ input speed are tolerated for intermittent duty applications only, because of the high temperature in crease resulting from the input rotation speed.

For these cases please contact technical department.

La selezione di motorizzazioni con velocità in entrata a 2800 min⁻¹ è ammessa per applicazioni intermittenti, dato l'elevato aumento della temperatura di funzionamento derivante dalla elevata velocità di rotazione.

In questo caso interpellare il nostro Servizio tecnico Commerciale.

**Irreversibility
Irreversibilità**

With wormgear boxes it is always important to consider the several levels of reversibility (or irreversibility) of the worm gear set, in order to guarantee a correct selection in applications where these requirements are essential for the operation of the machine. The following table shows the different tables of reversibility for worm gearboxes according to helix angle β and reduction ratio i .

Nei riduttori a vite senza fine è importante tenere in considerazione i vari gradi di reversibilità (o irreversibilità) della coppia vite-corona, per garantire una corretta selezione nelle applicazioni dove queste esigenze sono determinanti al fine del buon funzionamento dell'impianto. La tabella seguente riporta i vari gradi di reversibilità nei riduttori a vite senza fine definiti in base all'angolo d'elica β e al rapporto di riduzione i .

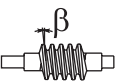
	030	045	050	063 63A	085	110	P45	P50	P63 P6A	P85	P10	303	453	503	633 6A3	634 6A4	854	115	
	i						i					i							
>25°		7		7	7	7	30.1												
12° - 25°	5 7 10 15	10 14	7 10	10 15	10 14 20 22	10 16 20 23	43.0 60.2	30.1 43.0			42 48 125						140		
8° - 12°	20	21	14 18	19 24			90.3	60.2 77.4	29.9 37.7 87.8 111				140 200 280 420						
5° - 8°	30	28	26 30 36	30 36 40	28 38 46 52	30 38 45 53 64	120	112 155	47.1 56.6 139 166	59.7 72.3 81.7 176 213 240 328	83.2 101 176 208 245 296 334 403	150 210 300 450 600 900	560	252 360 540 720	252 360 540 720 1080	252 360 504 756 1008	196 280 392 588 784	210 300 420 540 780 1080	
3° - 5°	40	37 46 60	43 50 60 68	45 60 67 80	67 74 96	84 99	159 198 258	185 258 292	70.7 208 310 370	105 422 466 605	132 529 624	1200	740 920 1120 1480 1840 2400	860 1200 1440 1720 2400	1440	1332 1656 2160	1036 1288	1290 1800 2040	
1° - 3°	61 80 100	70 102	80 100	94			301 439	344 430	434			1830 2400			2745	2520	1960 2856	2400 3000	

>25°	Totally reversible	Reversibilità totale
12° - 25°	Statically reversible Quick return Dynamically reversible	Staticamente reversibile Ritorno rapido Dinamicamente reversibile
8° - 12°	Variable static non-reversing Quick return in case of vibrations Dynamically reversible	Irreversibilità statica incerta Ritorno rapido in caso di vibrazioni Dinamicamente reversibile
5° - 8°	Statically non-reversing Return in case of vibrations Bad dynamic reversing	Staticamente irreversibile Ritorno in caso di vibrazioni Cattiva reversibilità dinamica
3° - 5°	Statically non-reversing Slow movement return in case of vibrations Low dynamic reversing*	Staticamente irreversibile Ritorno a scatti lenti in caso di vibrazioni Reversibilità dinamica quasi nulla*
1° - 3°	Statically non-reversing No return Low dynamic reversing*	Staticamente irreversibile Nessun ritorno Reversibilità dinamica quasi nulla*

* We would like to draw your attention on the fact that the total irreversibility cannot be guaranteed, therefore, where it is required, it is recommended to arrange an external braking device.

* Ci teniamo ad evidenziare che l'irreversibilità totale non può essere garantita pertanto, dove essa è richiesta, è necessario predisporre di un sistema di frenatura esterno al riduttore.

**RIGHTANGLE
WORM GEARBOXES**

The units from 030 to 085 are supplied with synthetic oil, providing "long life" lubrication. For mounting position V5 - V6 please contact us.

The unit 110 is supplied without lubricant and equipped with a breather, level and drain plugs. User can add mineral oil keeping existing plugs. Should the user wish to fill it with synthetic oil, it is recommended to replace the existing plugs with a closed plug.

The table hereafter must be referred to as for the mounting position pattern and the corresponding oil plugs, if applicable, and related lubricant quantity.

These quantity are only indicative; to ensure correct filling, always refer to the centreline of the sight glass. In some cases, discrepancies, occasionally also substantial, versus the oil quantities listed in the chart may be noticed.

**RIGHTANGLE
RIDUTTORI A VITE SENZA FINE**

I riduttori dal 030 al 085 sono forniti con lubrificazione a vita con olio sintetico . Per posizioni V5 - V6 contattare il nostro servizio tecnico.

Il riduttore 110 è fornito privo di lubrificazione con tappi di sfiato, livello e scarico olio. L'utente può immettere olio minerale mantenendo i tappi esistenti.

Se immetterà olio sintetico, dovrà sostituire i tappi esistenti con altri tipo chiuso.

Nelle tabelle sottostanti vengono rappresentate le posizioni di montaggio, la disposizione dei tappi olio e le relative quantità.

Le quantità di lubrificante sono indicative; per avere il corretto quantitativo di lubrificante si dovrà dare attinenza esclusivamente alla mezzeria del tappo livello o allo sfioramento del foro del tappo, quando presenti.

Tenendo in considerazione quanto appena sostenuto la quantità di lubrificante indicata in tabella può presentare delle differenze, occasionalmente anche rilevanti.

	AGIP Tellium VSF 320			SHELL Omala S4 WE 320		
030÷085	030	045	050	063	63A	085
Q.ty	0.03 Lt	0.09 Lt	0.14 Lt	0.40 Lt	0.40 Lt	1.2 Lt

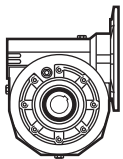
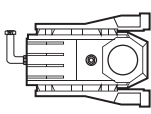
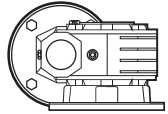
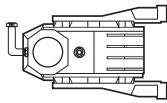
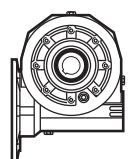
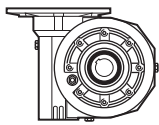
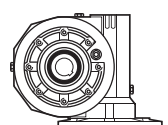
110	AGIP Blasias 460					
B3 ≅ Lt 1.90 oil	B6 ≅ Lt 1.35 oil (PB)	B7 ≅ Lt 1.35 oil (FB - FC - FL)	B7 ≅ Lt 1.35 oil (PA)	B8 ≅ Lt 2.00 oil	V5 ≅ Lt 2.00 oil	V6 ≅ Lt 2.00 oil
						

OIL PLUG POSITIONS - TYPES / POSIZIONE TAPPI OLIO - TIPI

data 28/06/18
LUB_VSF_01

□ These plugs are on the back side. ▼ Filling & Breather ▼ Filling closed △ Emptying ● Level

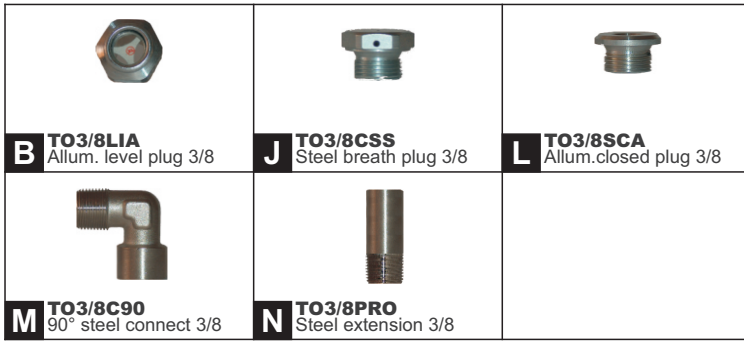

SYNTHETIC OIL	
Code	Description
LUOTVSF320 (Standard)	Synthetic oil 'Telium VSF320'
	Synthetic oil 'Omala S4 WE320'
LUOBLAS150 (Low temperature)	Synthetic oil 'Blasia S 150'
	Synthetic oil 'Omala S4 WE150'

MINERAL OIL	
Code	Description
LUOBLAM460	Mineral oil 'Blasia 460'
	Mineral oil 'Omala S2 G 460'

Standard

Type	030	045	050	063	63A	085	110
Oil q.ty (Lt.)	0.03	0.09	0.14	0.40	0.40	1.20	1.90
Std. oil plugs ①	-	-	-	-	-	-	-
On request	①	-	-	-	-	J	J
	②	-	-	-	-	B	B
	③	-	-	L	-	L	L
	④	-	-	-	-	L	L

B3

Type	030	045	050	063	63A	085	110	PA		PB	
								085	110	085	110
Oil q.ty (Lt.)	0.03	0.09	0.14	0.40	0.40	1.20	1.35	1.20	1.35	1.20	1.35
Std. oil plugs ①	-	-	-	-	-	-	-	-	-	-	-
On request	①	-	-	-	-	L	L	M+N+J	L	L	L
	②	-	-	-	-	B	B	B	B	B	B
	③	-	-	L	-	L	L	L	M+N+J	L	L
	④	-	-	-	-	J	J	L	L	L	L

B7

On request / A richiesta

Type	030	045	050	063	63A	085	110	PA		PB	
								085	110	085	110
Oil q.ty (Lt.)	0.03	0.09	0.14	0.40	0.40	1.20	1.35	1.20	1.35	1.20	1.35
Std. oil plugs ①	-	-	-	-	-	-	-	-	-	-	-
On request	①	-	-	-	-	L	L	M+N+J	L	L	L
	②	-	-	-	-	B	B	B	B	B	B
	③	-	-	L	-	M+N+J	M+N+J	L	M+N+J	L	L
	④	-	-	-	-	L	L	L	L	L	L

B6

Type	030	045	050	063	63A	085	110
Oil q.ty (Lt.)	0.03	0.09	0.14	0.40	0.40	1.20	2.00
Std. oil plugs ①	-	-	-	-	-	-	-
On request	①	-	-	-	-	L	L
	②	-	-	-	-	B	B
	③	-	-	L	-	J	J
	④	-	-	-	-	L	L

B8

Type	030	045	050	063	63A	085	110
Oil q.ty (Lt.)	0.03	0.09	0.14	0.40	0.40	1.20	2.00
Std. oil plugs ①	-	-	-	-	-	-	-
On request	①	-	-	-	-	J	J
	②	-	-	-	-	L	L
	③	-	-	L	-	B	B
	④	-	-	-	-	L	L

V5

Type	030	045	050	063	63A	085	110
Oil q.ty (Lt.)	0.03	0.09	0.14	0.40	0.40	1.20	2.00
Std. oil plugs ①	-	-	-	-	-	-	-
On request	①	-	-	-	-	L	L
	②	-	-	-	-	J	J
	③	-	-	L	-	B	B
	④	-	-	-	-	L	L

V6

**RIGHTANGLE
HELICAL WORMBOXES**

The units from P45 to P85 are supplied with synthetic oil, providing "long life" lubrication. For mounting position V5 - V6 please contact us.

P45 and P50 gearboxes are supplied only with common lubrication.

The unit 110 (P10) is supplied without lubricant and equipped with a breather, level and drain plugs. User can add mineral oil keeping existing plugs. Should the user wish to fill it with synthetic oil, it is recommended to replace the existing plugs with a closed plug.

The table hereafter must be referred to as for the mounting position pattern and the corresponding oil plugs, if applicable, and related lubricant quantity.

These quantity are only indicative; to ensure correct filling, always refer to the centreline of the sight glass. In some cases, discrepancies, occasionally also substantial, versus the oil quantities listed in the chart may be noticed.

**RIGHTANGLE
RIDUTTORI CON PRECOPPIA**

I riduttori dal P45 al P85 sono forniti con lubrificazione a vita ad olio sintetico . Per posizioni V5 - V6 contattare il nostro servizio tecnico.

I riduttori P45 e P50 sono forniti soltanto con lubrificazione comune.

Il riduttore 110 (P10) è fornito privo di lubrificazione con tappi di sfiato, livello e scarico olio. L'utente può immettere olio minerale mantenendo i tappi esistenti.

Se immetterà olio sintetico, dovrà sostituire i tappi esistenti con altri tipo chiuso.

Nelle tabelle sottostanti vengono rappresentate le posizioni di montaggio, la disposizione dei tappi olio e le relative quantità.

Le quantità di lubrificante sono indicative; per avere il corretto quantitativo di lubrificante si dovrà dare attinenza esclusivamente alla mezzeria del tappo livello o allo sfioramento del foro del tappo, quando presenti.

Tenendo in considerazione quanto appena sostenuto la quantità di lubrificante indicata in tabella può presentare delle differenze, occasionalmente anche rilevanti.

	P45		P50		P63		P6A		P85		P10	
	A	B	A	B	A	B	A	B	A	B	A	B
Separate lubrication Q.tà/Q.ty B3-V5-V6	-	-	-	-	0.40 Lt	0.08 Lt	0.40 Lt	0.08 Lt	1.20 Lt	0.14 Lt	2.0Lt	0.14 Lt
Common lubrication Q.tà/Q.ty B6-B7-B8	-	-	-	-	0.38 Lt		0.38 Lt		0.90 Lt		1.9Lt	-
Common lubrication for all position	0.17 Lt		0.26 Lt		-		-		-		-	

□ These plugs are on the back side. ▼ Filling & Breather ▼ Filling closed △ Emptying ● Level

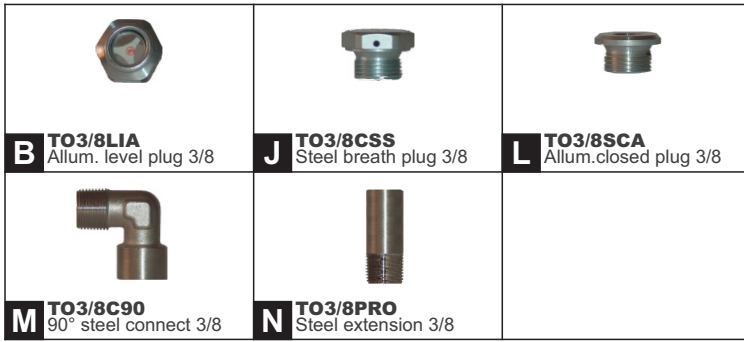

SYNTHETIC OIL	
Code	Description
LUOTVSF320 (Standard)	Synthetic oil 'Telium VSF320'
	Synthetic oil 'Omala S4 WE320'
LUOBLAS150 (Low temperature)	Synthetic oil 'Blasia S 150'
	Synthetic oil 'Omala S4 WE150'

MINERAL OIL	
Code	Description
LUOBLAM460	Mineral oil 'Blasia 460'
	Mineral oil 'Omala S2 G 460'

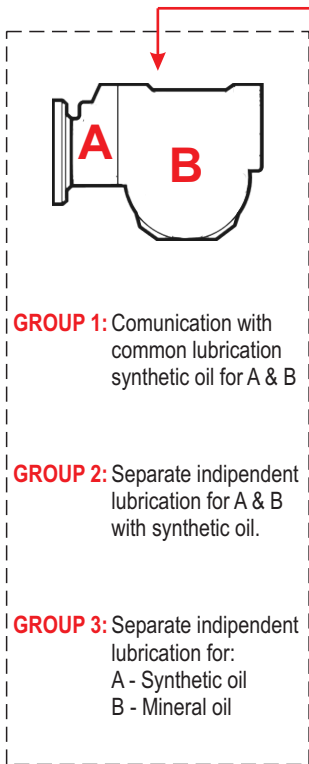

Type	GROUP 1		GROUP 2			GROUP 3
	P45	P50	P63	P6A	P85	P10
Standard B3	Oil q.ty (Lt.) B 0.17	Oil q.ty (Lt.) A 0.26	0.40	0.40	1.20	1.90
	Std. oil plugs ①	-	-	-	-	-
On request	①	-	-	-	J	J
	②	-	-	-	B	B
	③	L	L	L	L	L
	④	-	-	-	L	L
B7	Oil q.ty (Lt.) B 0.17	Oil q.ty (Lt.) A 0.26	0.38	0.38	0.90	1.50
	Std. oil plugs ①	-	-	-	-	-
On request	①	-	-	-	L	L
	②	-	-	-	B	B
	③	L	L	L	L	L
	④	-	-	-	J	J
B6	Oil q.ty (Lt.) B 0.17	Oil q.ty (Lt.) A 0.26	0.38	0.38	0.90	1.50
	Std. oil plugs ①	-	-	-	-	-
On request	①	-	-	-	L	L
	②	-	-	-	B	B
	③	L	L	L	M+N+J	M+N+J
	④	-	-	-	L	L
B8	Oil q.ty (Lt.) B 0.17	Oil q.ty (Lt.) A 0.26	0.38	0.38	0.90	2.00
	Std. oil plugs ①	-	-	-	-	0.14
On request	①	-	-	-	L	L
	②	-	-	-	B	B
	③	L	L	L	J	J
	④	-	-	-	L	L
V5	Oil q.ty (Lt.) B 0.17	Oil q.ty (Lt.) A 0.26	0.40	0.40	1.20	2.00
	Std. oil plugs ①	-	-	-	-	-
On request	①	-	-	-	J	J
	②	-	-	-	L	L
	③	L	L	L	B	B
	④	-	-	-	L	L
V6	Oil q.ty (Lt.) B 0.17	Oil q.ty (Lt.) A 0.26	0.40	0.40	1.20	2.00
	Std. oil plugs ①	-	-	-	-	-
On request	①	-	-	-	L	L
	②	-	-	-	J	J
	③	L	L	L	B	B
	④	-	-	-	L	L

On request / A richiesta

**RIGHTANGLE
DOUBLE WORMBOXES VSF**

The units from 303 to 854 are supplied with synthetic oil, providing "long life" lubrication. For mounting position V5 - V6 please contact us.

The unit 115 (110+050) , 110 is supplied without lubricant and equipped with a breather, level and drain plugs. User can add mineral oil keeping existing plugs. Should the user wish to fill it with synthetic oil, it is recommended to replace the existing plugs with a closed plug.

The table hereafter must be referred to as for the mounting position pattern and the corresponding oil plugs, if applicable, and related lubricant quantity.

These quantity are only indicative; to ensure correct filling, always refer to the centreline of the sight glass. In some cases, discrepancies, occasionally also substantial, versus the oil quantities listed in the chart may be noticed.

**RIGHTANGLE
RIDUTTORI COMBINATI VSF**

I riduttori dal 303 al 854 sono forniti con lubrificazione a vita ad olio sintetico . Per posizioni V5 - V6 contattare il nostro servizio tecnico.

Il riduttore 115 (110+050) , 110 è fornito privo di lubrificazione con tappi di sfiato, livello e scarico olio. L'utente può immettere olio minerale mantenendo i tappi esistenti. Se immetterà olio sintetico, dovrà sostituire i tappi esistenti con altri tipo chiuso.

Nelle tabelle sottostanti vengono rappresentate le posizioni di montaggio, la disposizione dei tappi olio e le relative quantità.

Le quantità di lubrificante sono indicative; per avere il corretto quantitativo di lubrificante si dovrà dare attinenza esclusivamente alla mezzeria del tappo livello o allo sfioramento del foro del tappo, quando presenti.

Tenendo in considerazione quanto appena sostenuto la quantità di lubrificante indicata in tabella può presentare delle differenze, occasionalmente anche rilevanti.

	AGIP Tellium VSF 320			SHELL Omala S4 WE 320		
453+854	303	453	503	633-6A3	634-6A4	854
	030+030	045+030	050+030	063 / 63A+030	063 / 63A+045	085+045
Q.tà/Q.ty	0.03 / 0.03 Lt	0.09 / 0.03 Lt	0.14 / 0.03 Lt	0.40 / 0.03 Lt	0.40 / 0.09 Lt	1.2 / 0.09 Lt

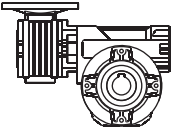
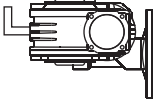
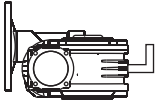
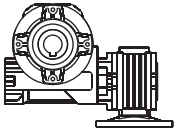
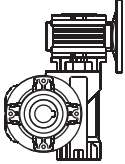
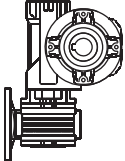
115	AGIP Blasias 460					
B3 1.9 / 0.14 Lt	B6 1.5 / 0.14 Lt	B7 1.5 / 0.14 Lt	B8 2.0 / 0.14 Lt	V5 2.0 / 0.14 Lt	V6 2.0 / 0.14 Lt	
						

OIL PLUG POSITIONS - TYPES / POSIZIONE TAPPI OLIO - TIPI

data 28/06/18
LUB_VSF_03

☐ These plugs are on the back side. ▼ Filling & Breather ▼ Filling closed △ Emptying ● Level

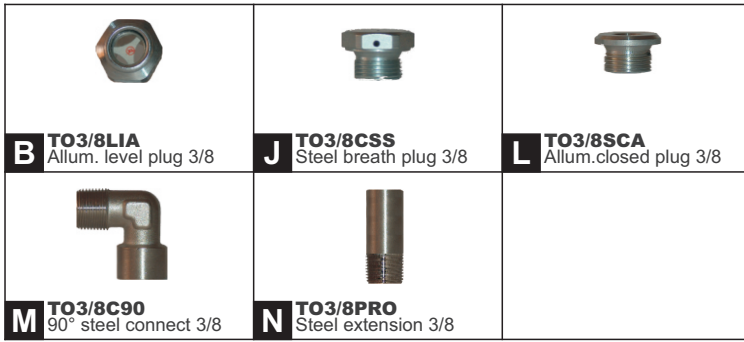

SYNTHETIC OIL	
Code	Description
LUOTVSF320 (Standard)	Synthetic oil 'Telium VSF320'
	Synthetic oil 'Omala S4 WE320'
LUOBLAS150 (Low temperature)	Synthetic oil 'Blasia S 150'
	Synthetic oil 'Omala S4 WE150'

MINERAL OIL	
Code	Description
LUOBLAM460	Mineral oil 'Blasia 460'
	Mineral oil 'Omala S2 G 460'

Standard	Type	SYNTHETIC OIL									
		303	453	503	633	634	6A3	6A4	854	115	
<p>B3</p>	Oil q.ty (Lt.) B	0.03	0.09	0.14	0.40	0.40	0.40	0.40	1.20	1.90 Mineral Oil	
	Oil q.ty (Lt.) A	0.03	0.03	0.03	0.03	0.09	0.03	0.09	0.09	0.14 Synth. Oil	
	Std. oil plugs ①	-	-	-	-	-	-	-	-	-	
	On request	①	-	-	-	-	-	-	-	J	J
		②	-	-	-	-	-	-	-	B	B

Only for 115 (110+050) lubrication 110 with mineral oil 050 with synthetic oil

<p>B7</p>	Oil q.ty (Lt.) B	0.03	0.09	0.14	0.40	0.40	0.40	0.40	1.20	1.50 Mineral Oil	
	Oil q.ty (Lt.) A	0.03	0.03	0.03	0.03	0.09	0.03	0.09	0.09	0.14 Synth. Oil	
	Std. oil plugs ①	-	-	-	-	-	-	-	-	-	
	On request	①	-	-	-	-	-	-	-	L	L
		②	-	-	-	-	-	-	-	B	B

<p>B6</p>	Oil q.ty (Lt.) B	0.03	0.09	0.14	0.40	0.40	0.40	0.40	1.20	1.50 Mineral Oil	
	Oil q.ty (Lt.) A	0.03	0.03	0.03	0.03	0.09	0.03	0.09	0.09	0.14 Synth. Oil	
	Std. oil plugs ①	-	-	-	-	-	-	-	-	-	
	On request	①	-	-	-	-	-	-	-	L	L
		②	-	-	-	-	-	-	-	B	B











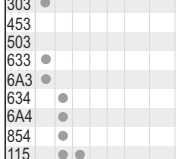

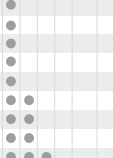
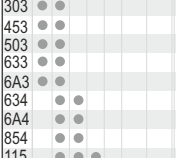
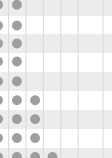
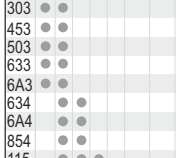

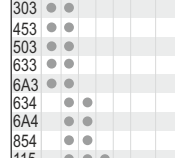
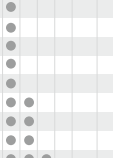
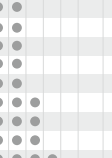

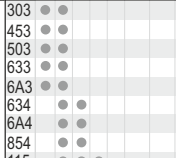
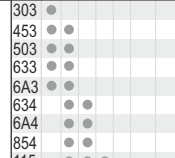

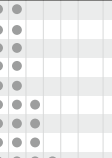

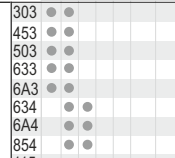
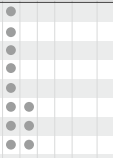
<p>B8</p>	Oil q.ty (Lt.) B	0.03	0.09	0.14	0.40	0.40	0.40	0.40	1.20	2.00 Mineral Oil	
	Oil q.ty (Lt.) A	0.03	0.03	0.03	0.03	0.09	0.03	0.09	0.09	0.14 Synth. Oil	
	Std. oil plugs ①	-	-	-	-	-	-	-	-	-	
	On request	①	-	-	-	-	-	-	-	L	L
		②	-	-	-	-	-	-	-	B	B

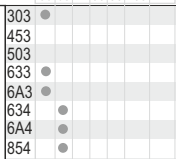
<p>V5</p>	Oil q.ty (Lt.) B	0.03	0.09	0.14	0.40	0.40	0.40	0.40	1.20	2.00 Mineral Oil	
	Oil q.ty (Lt.) A	0.03	0.03	0.03	0.03	0.09	0.03	0.09	0.09	0.14 Synth. Oil	
	Std. oil plugs ①	-	-	-	-	-	-	-	-	-	
	On request	①	-	-	-	-	-	-	-	J	J
		②	-	-	-	-	-	-	-	L	L

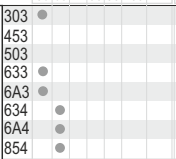
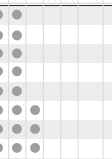
<p>V6</p>	Oil q.ty (Lt.) B	0.03	0.09	0.14	0.40	0.40	0.40	0.40	1.20	2.00 Mineral Oil	
	Oil q.ty (Lt.) A	0.03	0.03	0.03	0.03	0.09	0.03	0.09	0.09	0.14 Synth. Oil	
	Std. oil plugs ①	-	-	-	-	-	-	-	-	-	
	On request	①	-	-	-	-	-	-	-	L	L
		②	-	-	-	-	-	-	-	J	J

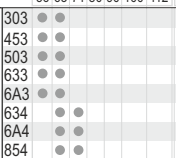
On request / A richiesta

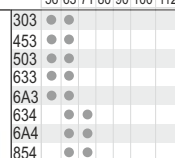
MOUNTING POSITIONS / ESECUZIONI DI MONTAGGIO

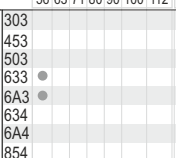
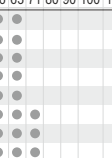
FB			FC/FL			FC/FL		
P1	B5 56 63 71 80 90 100 112	B14 56 63 71 80 90 100 112	P1R	B5 56 63 71 80 90 100 112	B14 56 63 71 80 90 100 112	P1L	B5 56 63 71 80 90 100 112	B14 56 63 71 80 90 100 112
	303 453 503 633 6A3 634 6A4 854 115							
P2	B5 56 63 71 80 90 100 112	B14 56 63 71 80 90 100 112	P2R	B5 56 63 71 80 90 100 112	B14 56 63 71 80 90 100 112	P2L	B5 56 63 71 80 90 100 112	B14 56 63 71 80 90 100 112
	303 453 503 633 6A3 634 6A4 854 115							
Q1	B5 56 63 71 80 90 100 112	B14 56 63 71 80 90 100 112	Q1R	B5 56 63 71 80 90 100 112	B14 56 63 71 80 90 100 112	Q1L	B5 56 63 71 80 90 100 112	B14 56 63 71 80 90 100 112
	303 453 503 633 6A3 634 6A4 854 115							
Q2	B5 56 63 71 80 90 100 112	B14 56 63 71 80 90 100 112	Q2R	B5 56 63 71 80 90 100 112	B14 56 63 71 80 90 100 112	Q2L	B5 56 63 71 80 90 100 112	B14 56 63 71 80 90 100 112
	303 453 503 633 6A3 634 6A4 854 115							
R1	B5 56 63 71 80 90 100 112	B14 56 63 71 80 90 100 112	R1R	B5 56 63 71 80 90 100 112	B14 56 63 71 80 90 100 112	R1L	B5 56 63 71 80 90 100 112	B14 56 63 71 80 90 100 112
	303 453 503 633 6A3 634 6A4 854 115							
R2	B5 56 63 71 80 90 100 112	B14 56 63 71 80 90 100 112	R2R	B5 56 63 71 80 90 100 112	B14 56 63 71 80 90 100 112	R2L	B5 56 63 71 80 90 100 112	B14 56 63 71 80 90 100 112
	303 453 503 633 6A3 634 6A4 854 115							
S1	B5 56 63 71 80 90 100 112	B14 56 63 71 80 90 100 112	S1R	B5 56 63 71 80 90 100 112	B14 56 63 71 80 90 100 112	S1L	B5 56 63 71 80 90 100 112	B14 56 63 71 80 90 100 112
	303 453 503 633 6A3 634 6A4 854 115							
S2	B5 56 63 71 80 90 100 112	B14 56 63 71 80 90 100 112	S2R	B5 56 63 71 80 90 100 112	B14 56 63 71 80 90 100 112	S2L	B5 56 63 71 80 90 100 112	B14 56 63 71 80 90 100 112
	303 453 503 633 6A3 634 6A4 854 115							

303 FL is not available 63B14

303 FL is not available 63B14

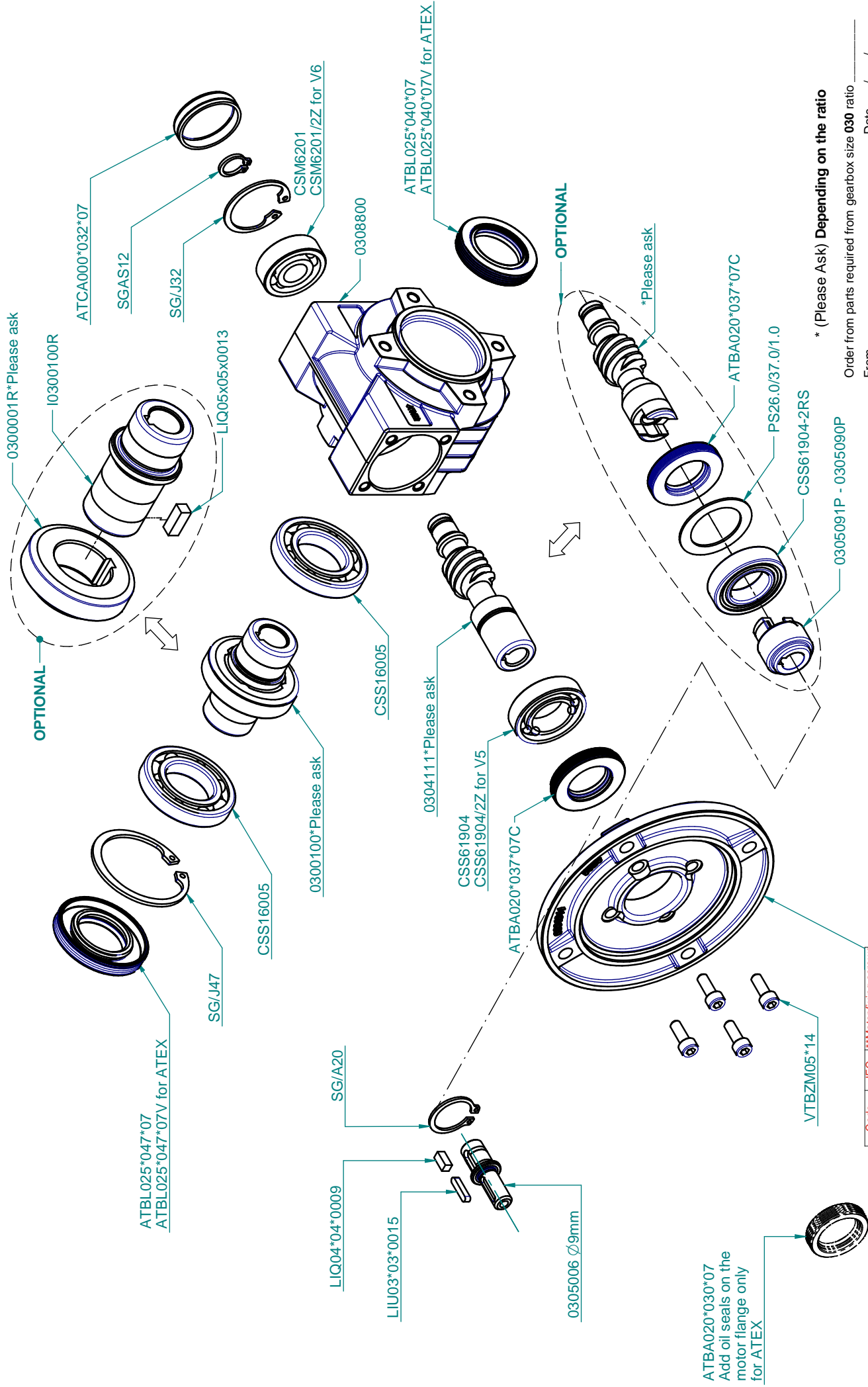

* (Please Ask) Depending on the ratio

Order from parts required from gearbox size 030 ratio

From _____ Date _____ / _____ / _____

Code	IEC	**Motor fixing screws
030.4.041	56 B5	n°4 M6x30 T.E.
030.4.042	63 B5	n°4 M8x30 T.E.
030.4.046	56 B14	n°4 M5x16 T.E.
030.4.045	63 B14	n°4 M5x16 T.E.

Parts	Q.ty	Description

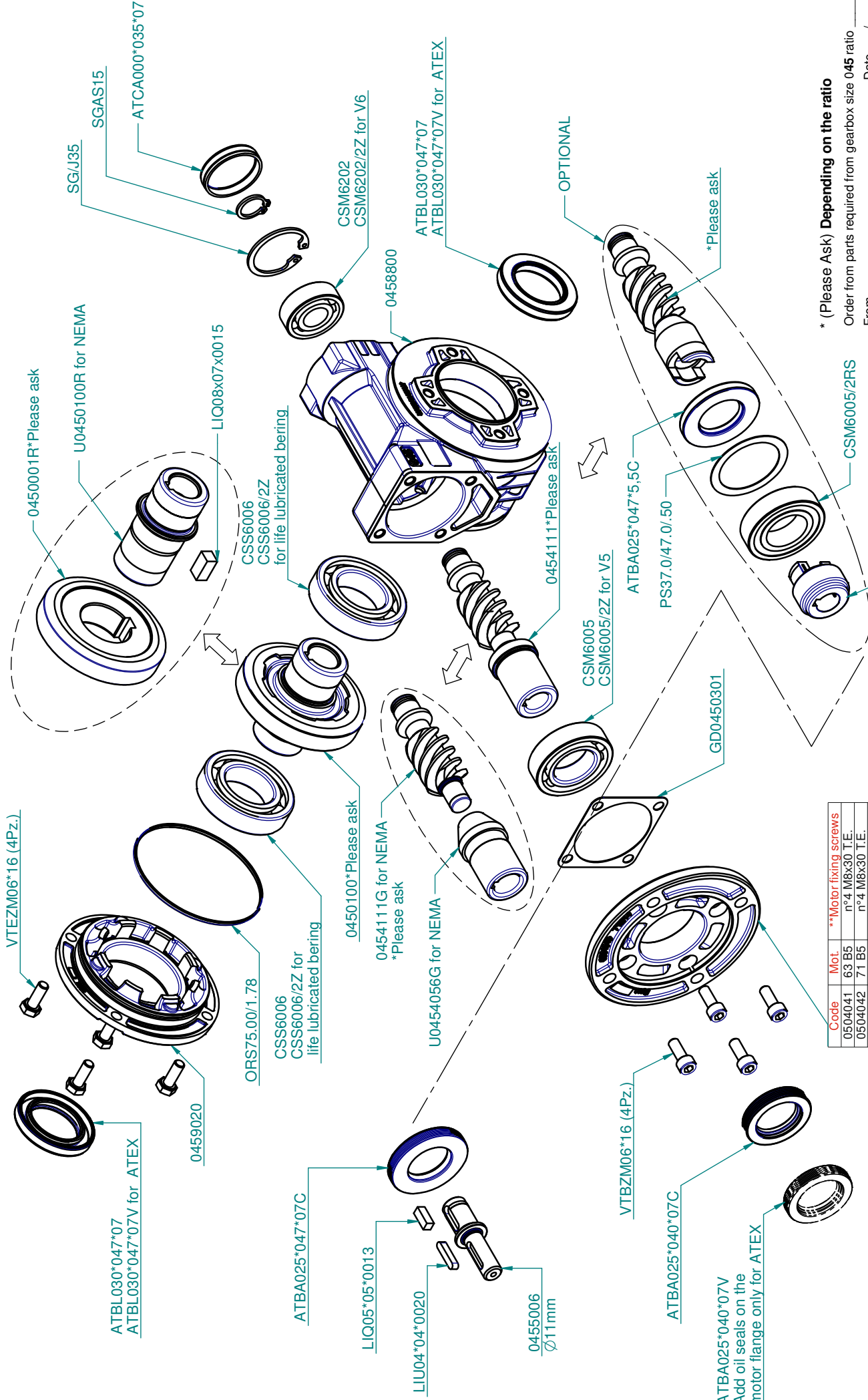

Code	Mot.	**Motor fixing screws
0504041	63 B5	n°4 M8x30 T.E.
0504042	71 B5	n°4 M8x30 T.E.
C404049	56 B14	n°4 M5x16 T.E.
0504047	63 B14	n°4 M5x16 T.E.
0504045	71 B14	n°4 M6x20 T.E.
U0504041	56C	-

* (Please Ask) Depending on the ratio

Order from parts required from gearbox size 045 ratio

From _____ Date _____

Parts	Qty	Description

Fax: +39 0444 536139 ---- e-mail: hydromec@hydromec.com

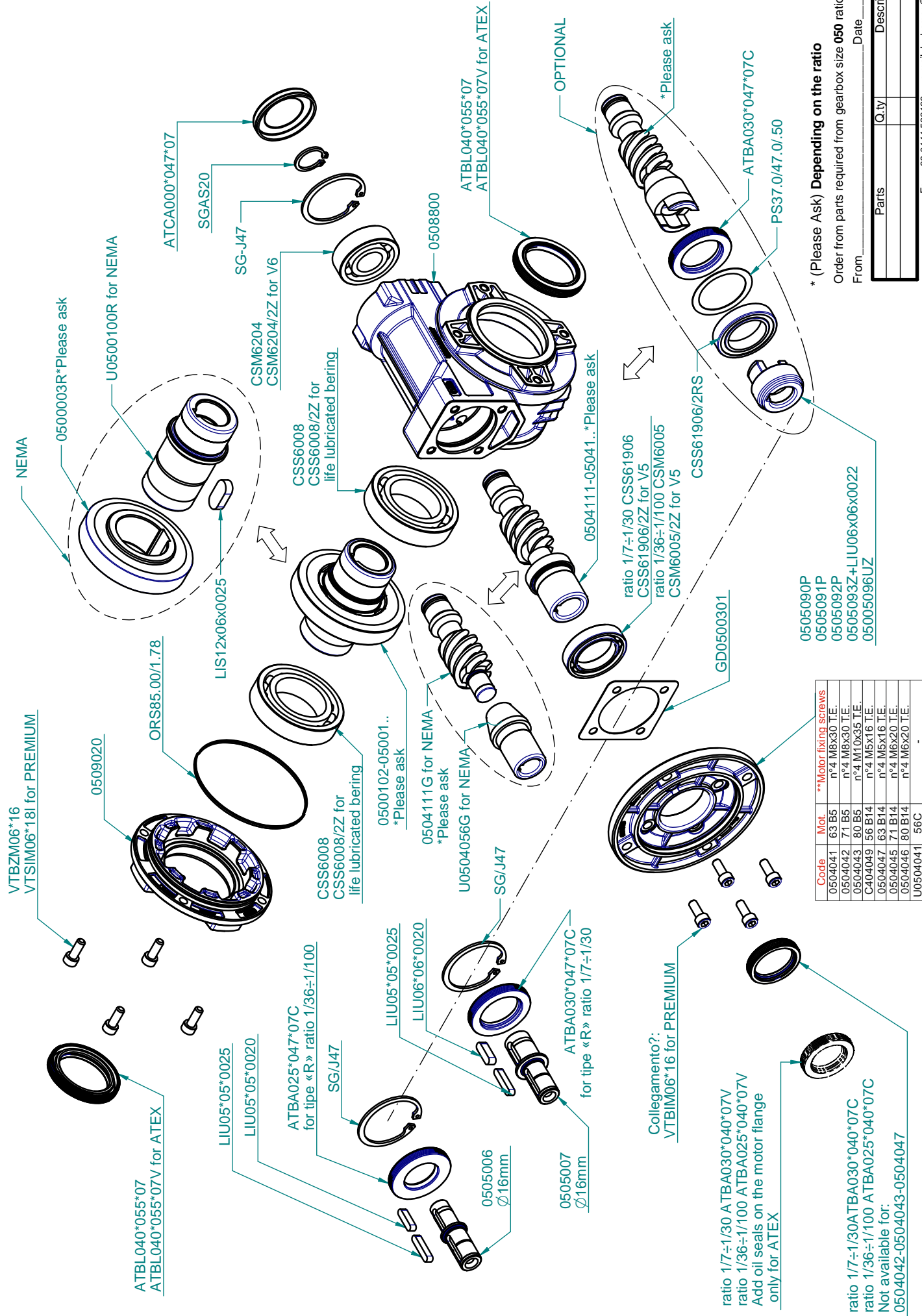

Code	Mot.	**Motor fixing screws
0504041	63 B5	n°4 M8x30 T.E.
0504042	71 B5	n°4 M8x30 T.E.
0504043	80 B5	n°4 M10x35 T.E.
C404049	56 B74	n°4 M5x16 T.E.
0504047	63 B14	n°4 M5x16 T.E.
0504045	71 B14	n°4 M6x20 T.E.
0504046	80 B14	n°4 M6x20 T.E.
U0504041	56C	-

*** (Please Ask) Depending on the ratio**
Order from parts required from gearbox size **050** ratio _____
From _____ Date _____ / _____ / _____

Parts	Q.ty	Description

Fax: +39 0444 536139 ---- e-mail: hydromec@hydromec.com

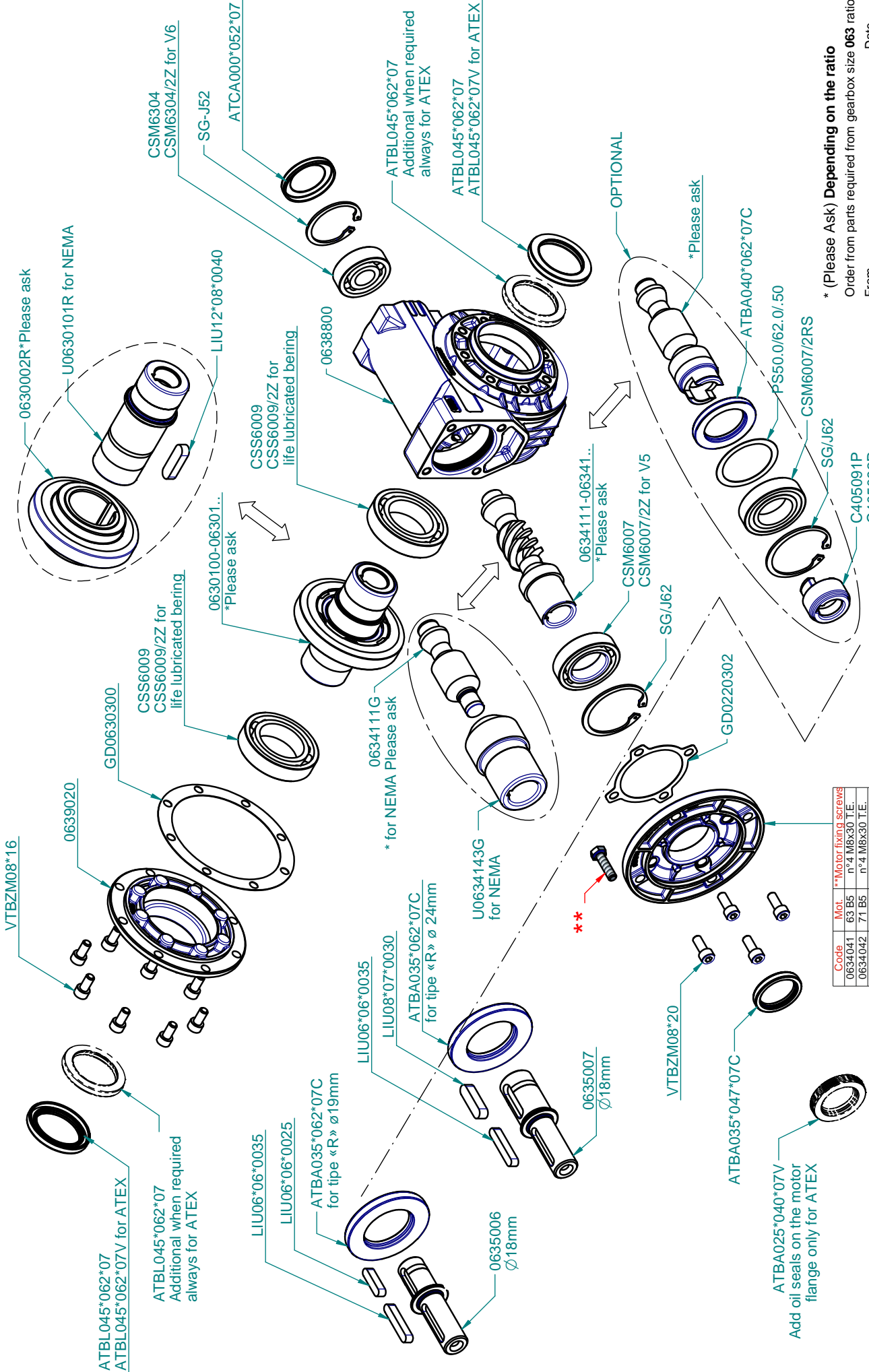

Code	Mot.	**Motor fixing screws
0634041	63 B5	n°4 M8x30 T.E.
0634042	71 B5	n°4 M8x30 T.E.
0634043	80 B5	n°4 M10x35 T.E.
0634043	90 B5	n°4 M10x35 T.E.
0634047	71 B14	n°4 M6x20 T.E.
0634046	80 B14	n°4 M6x20 T.E.
0634041	90 B14	n°4 M8x20 T.E.
U0634041143/51C	-	-

* (Please Ask) Depending on the ratio

Order from parts required from gearbox size **063** ratio _____
 From _____ Date _____ / _____ / _____

Parts	Qty	Description

Fax: +39 0444 536139 ---- e-mail: hydromec@hydromec.com

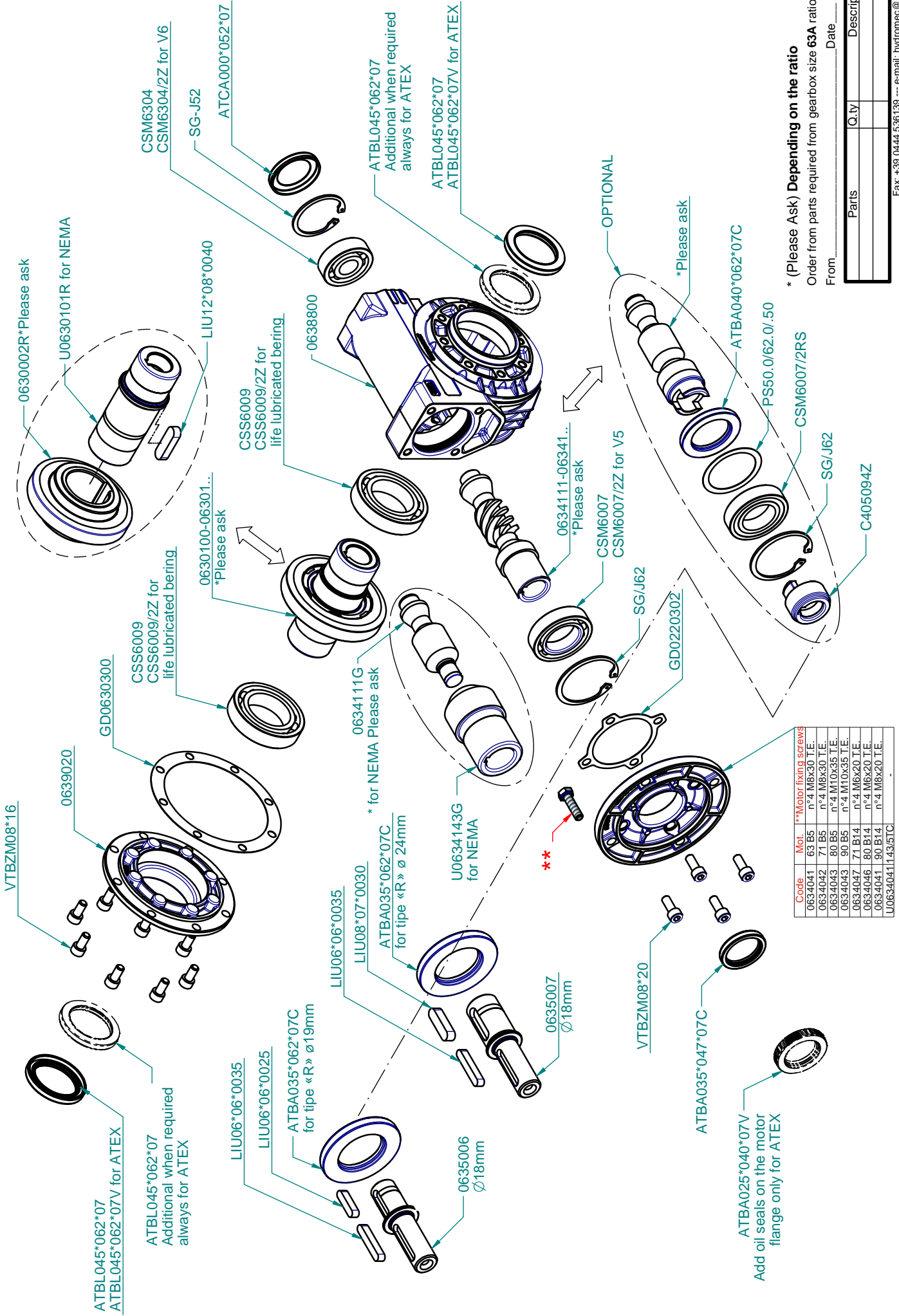

Code	Mot	**Motor fixing screws
0634041	63 B5	n°4 M8x30 T.E.
0634042	71 B5	n°4 M8x30 T.E.
0634043	80 B5	n°4 M10x35 T.E.
0634044	90 B5	n°4 M10x35 T.E.
0634047	71 B14	n°4 M6x20 T.E.
0634046	80 B14	n°4 M6x20 T.E.
0634041	90 B14	n°4 M8x20 T.E.
U0634041	1.43/5TC	-

* (Please Ask) Depending on the ratio

Order from parts required from gearbox size 63A ratio

From _____ Date _____ / _____ / _____

Parts	Qty	Description

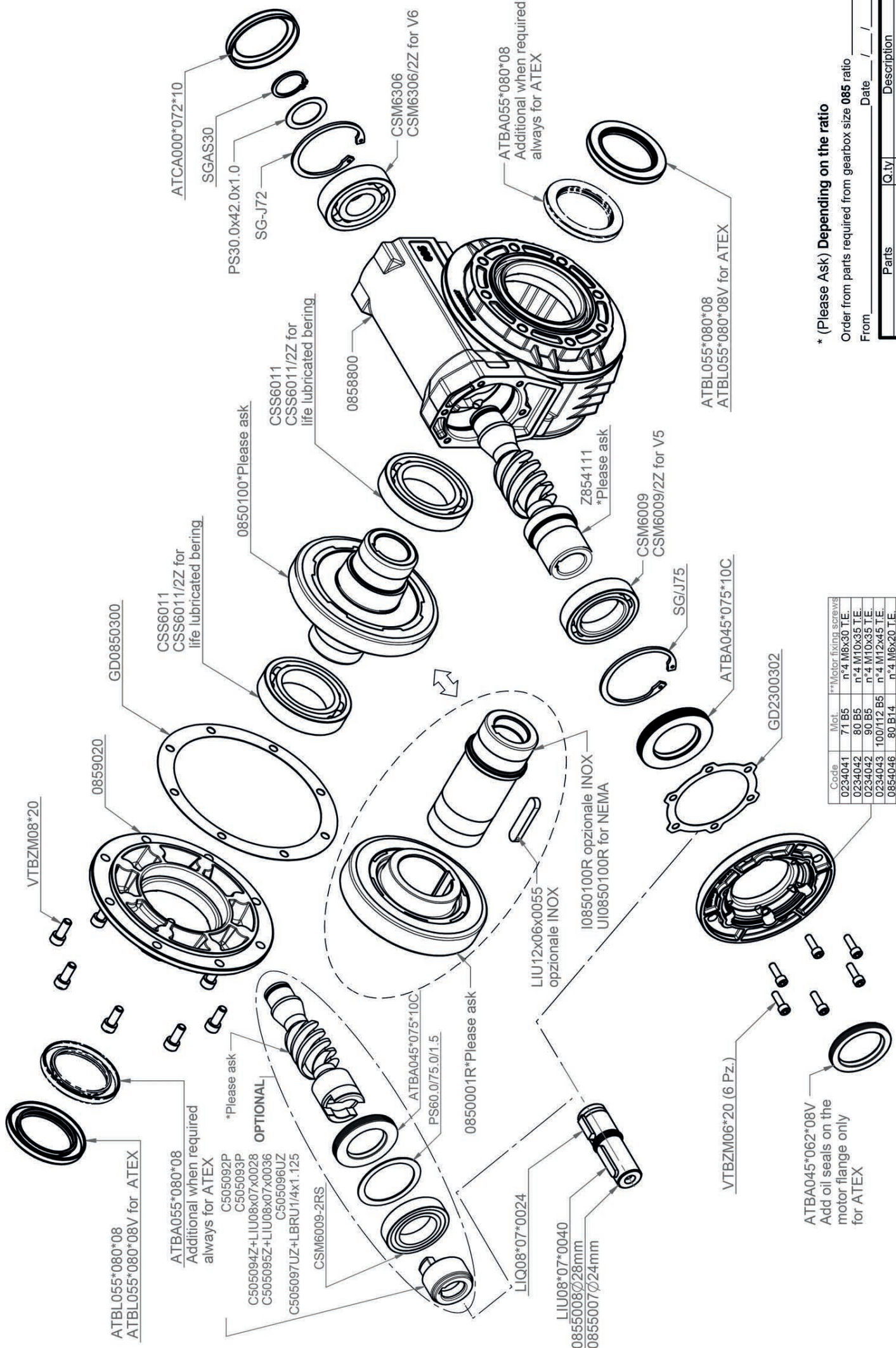

*** (Please Ask) Depending on the ratio**

Order from parts required from gearbox size **085** ratio _____

From _____ Date ____/____/____

Parts	Q.ty	Description

Code	Mot	**Motor fixing screws
0234041	71 B5	n°4 M8x30 T.E.
0234042	80 B5	n°4 M10x35 T.E.
0234042	90 B5	n°4 M10x35 T.E.
0234043	100/112 B5	n°4 M12x45 T.E.
0854046	80 B14	n°4 M8x20 T.E.
0854045	90 B14	n°4 M8x20 T.E.
0854047	100/112 B14	n°4 M8x20 T.E.
U0854041	143/51C	-
U0854042	182/41C	-

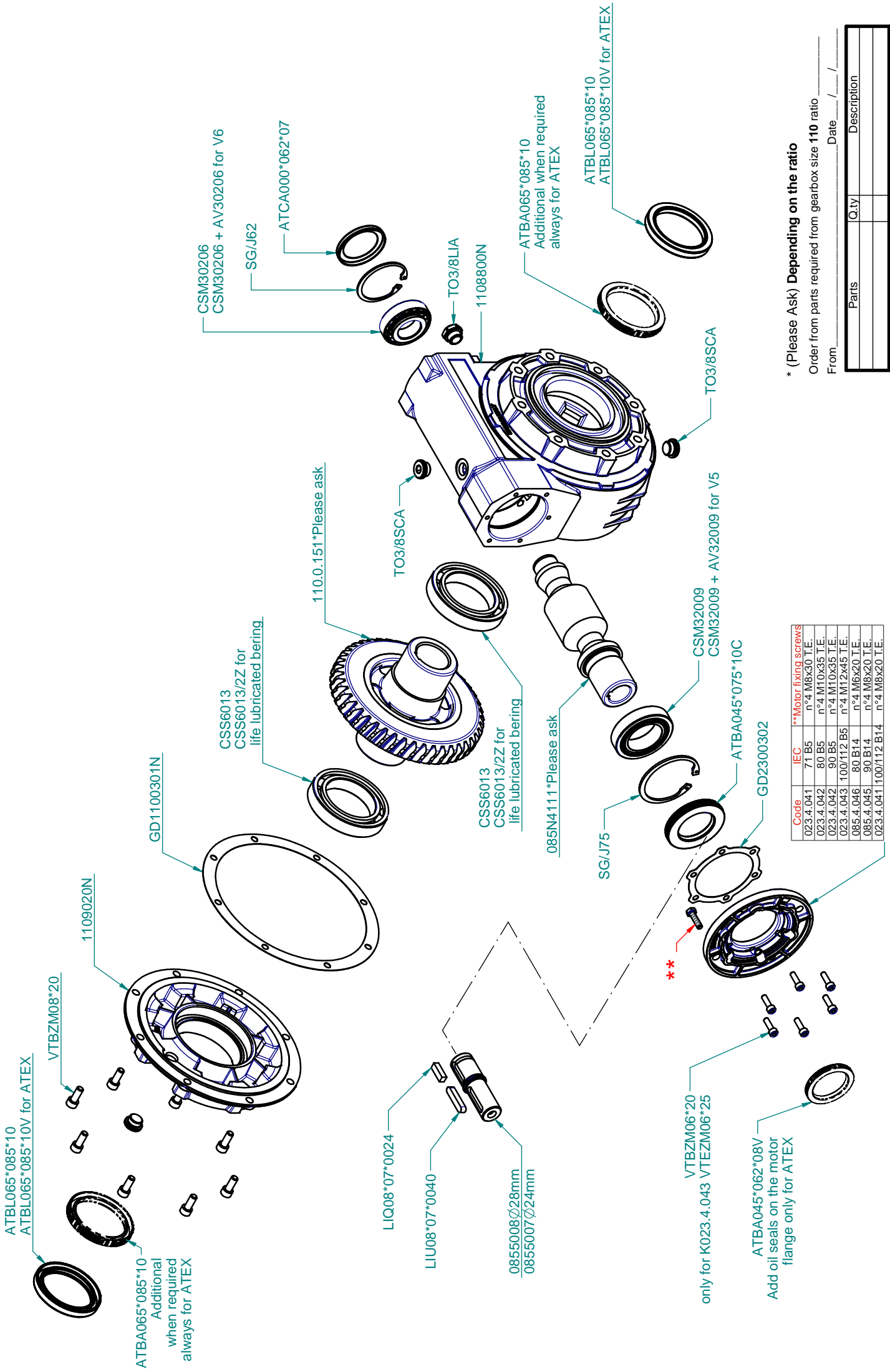

* (Please Ask) Depending on the ratio

Order from parts required from gearbox size 110 ratio
From _____ Date ____/____/____

Parts	Qty	Description

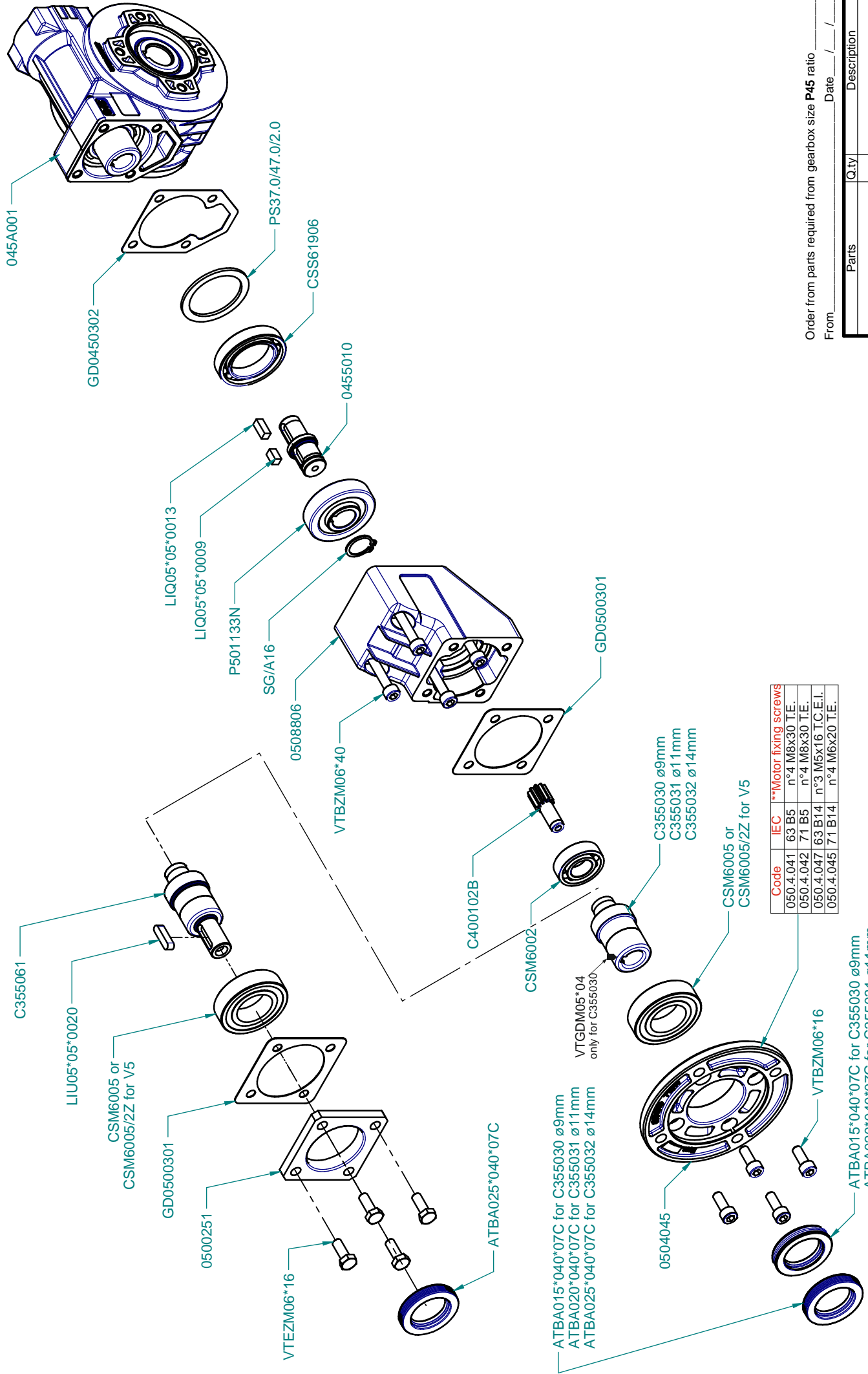

Code	IEC	**Motor fixing screws
050.4.041	63 B5	n°4 M8x30 T.E.
050.4.042	71 B5	n°4 M8x30 T.E.
050.4.047	63 B14	n°3 M5x16 T.C.E.I.
050.4.045	71 B14	n°4 M6x20 T.E.

Order from parts required from gearbox size **P45** ratio _____

From _____ Date ____/____/____

Parts	Q.ty	Description

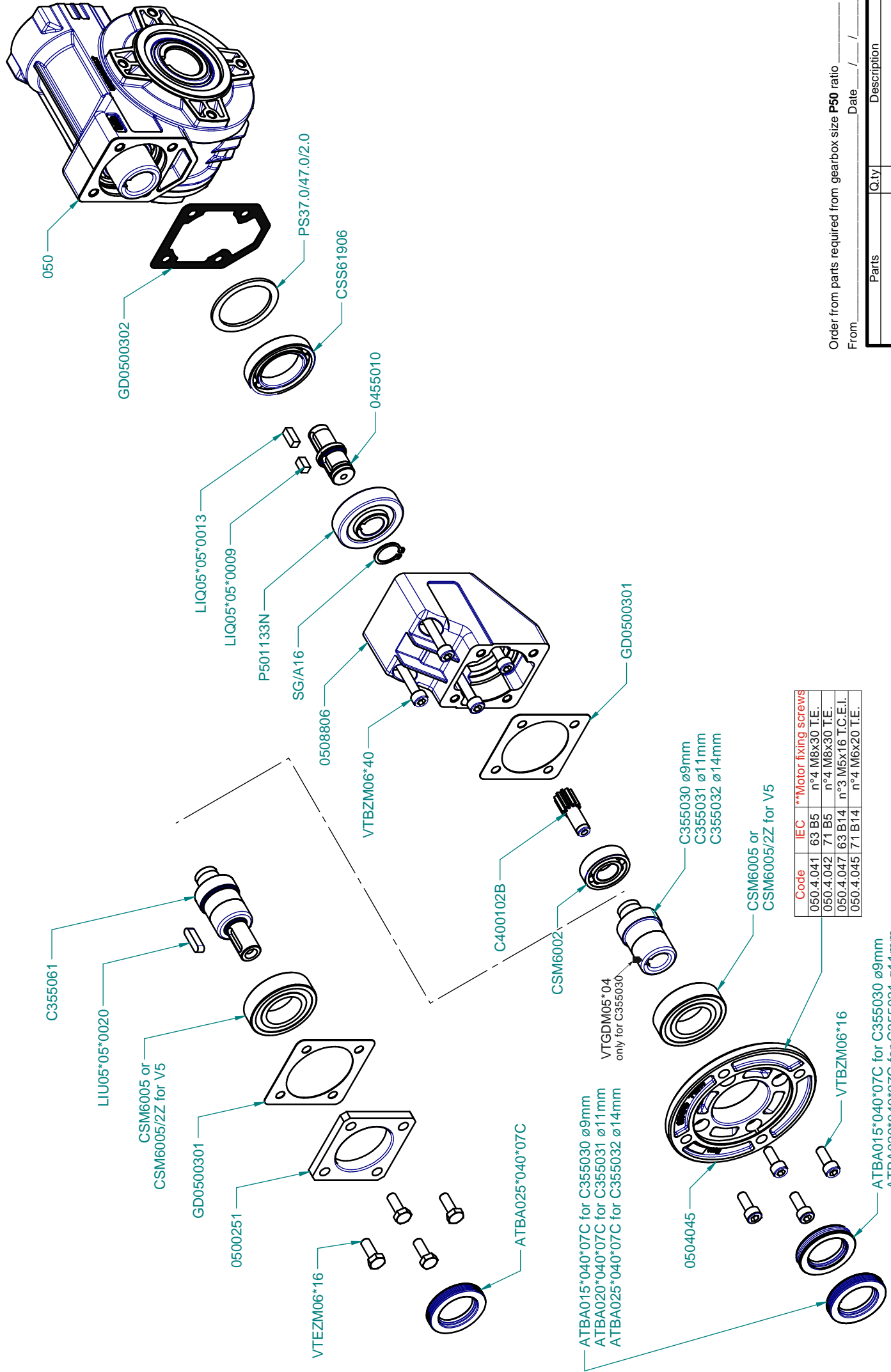

Code	IEC	**Motor fixing screws
050.4.041	63 B5	n°4 M8x30 T.E.
050.4.042	71 B5	n°4 M8x30 T.E.
050.4.047	63 B14	n°3 M5x16 T.C.E.I.
050.4.045	71 B14	n°4 M6x20 T.E.

Order from parts required from gearbox size **P50** ratio _____

From _____ Date ____/____/____

Parts	Q.ty	Description

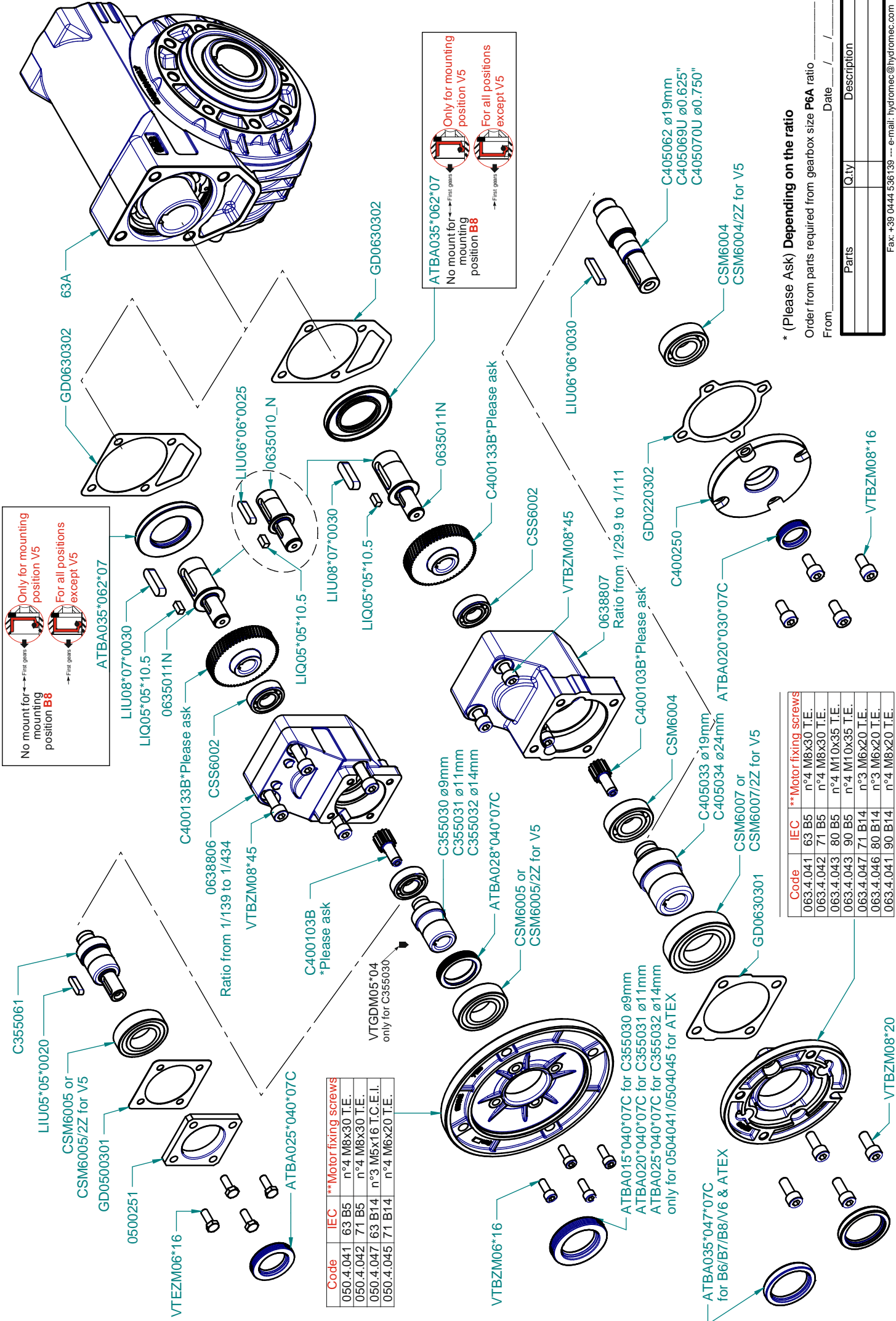

No mount for mounting position B8
 Only for mounting position V5
 For all positions except V5

ATBA035*062*07
 No mount for mounting position B8
 Only for mounting position V5
 For all positions except V5

Code	IEC	**Motor fixing screws
050.4.041	63 B5	n°4 M8x30 T.E.
050.4.042	71 B5	n°4 M8x30 T.E.
050.4.047	63 B14	n°3 M5x16 T.C.E.I.
050.4.045	71 B14	n°4 M6x20 T.E.

Code	IEC	**Motor fixing screws
063.4.041	63 B5	n°4 M8x30 T.E.
063.4.042	71 B5	n°4 M8x30 T.E.
063.4.043	80 B5	n°4 M10x35 T.E.
063.4.043	90 B5	n°4 M10x35 T.E.
063.4.047	71 B14	n°3 M6x20 T.E.
063.4.046	80 B14	n°3 M6x20 T.E.
063.4.041	90 B14	n°4 M8x20 T.E.

* (Please Ask) Depending on the ratio

Order from parts required from gearbox size P6A ratio

From: _____ Date: ____/____/____

Parts	Q.ty	Description

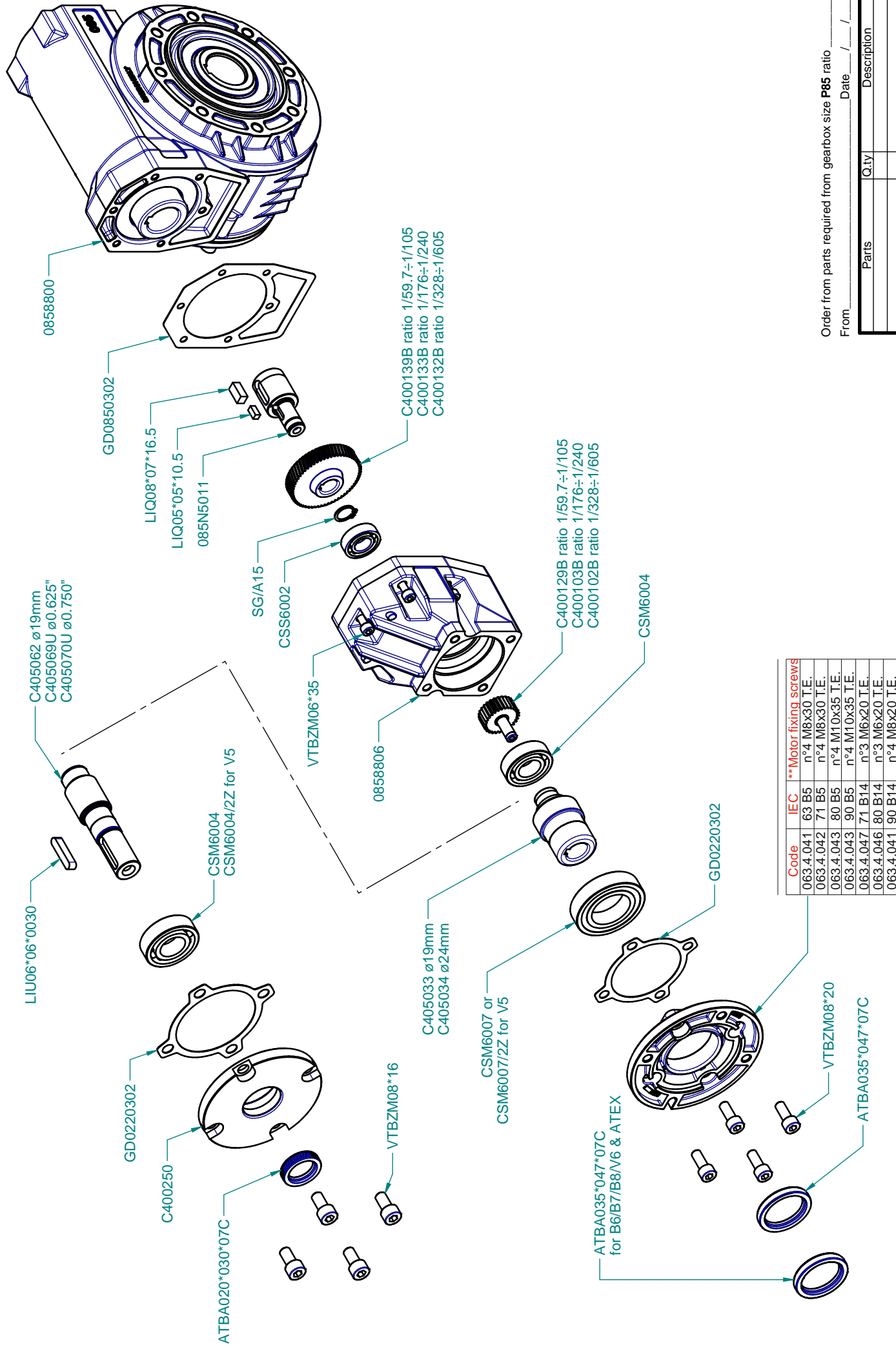

Code	IEC	** Motor fixing screws
063.4.041	63 B5	n°4 M8x30 T.E.
063.4.042	71 B5	n°4 M8x30 T.E.
063.4.043	80 B5	n°4 M10x35 T.E.
063.4.043	90 B5	n°4 M10x35 T.E.
063.4.047	71 B14	n°3 M6x20 T.E.
063.4.046	80 B14	n°3 M6x20 T.E.
063.4.041	90 B14	n°4 M8x20 T.E.

Order from parts required from gearbox size **P85** ratio _____
From _____ Date ____/____/____

Parts	Q.ty	Description

Fax: +39 0444 536139 ---- e-mail: hydromec@hydromec.com

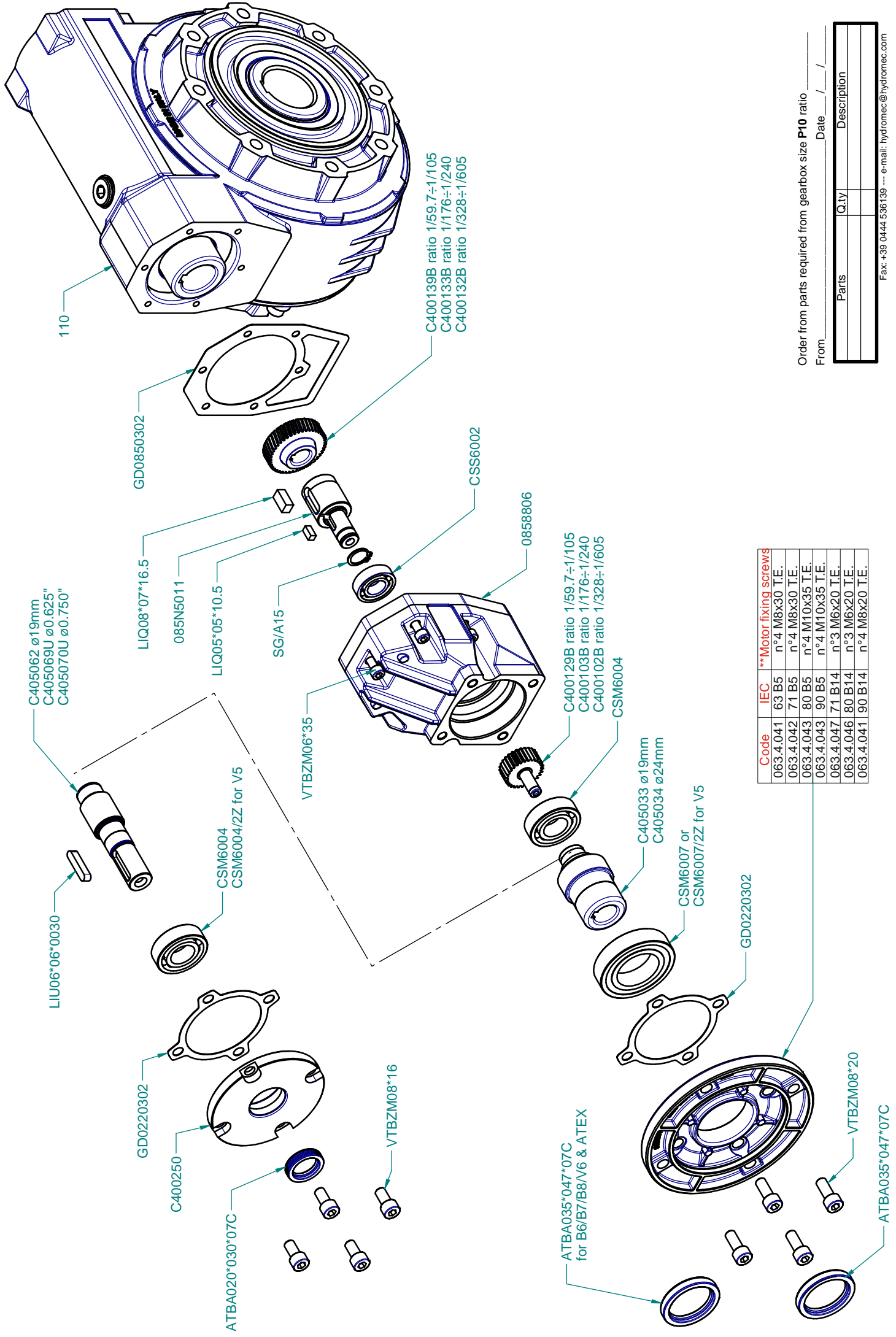

Code	IEC	**Motor fixing screws
063.4.041	63 B5	n°4 M8x30 T.E.
063.4.042	71 B5	n°4 M8x30 T.E.
063.4.043	80 B5	n°4 M10x35 T.E.
063.4.043	90 B5	n°4 M10x35 T.E.
063.4.047	71 B14	n°3 M6x20 T.E.
063.4.046	80 B14	n°3 M6x20 T.E.
063.4.041	90 B14	n°4 M8x20 T.E.

Order from parts required from gearbox size P10 ratio _____
 From _____ Date ____/____/____

Parts	Q.ty	Description

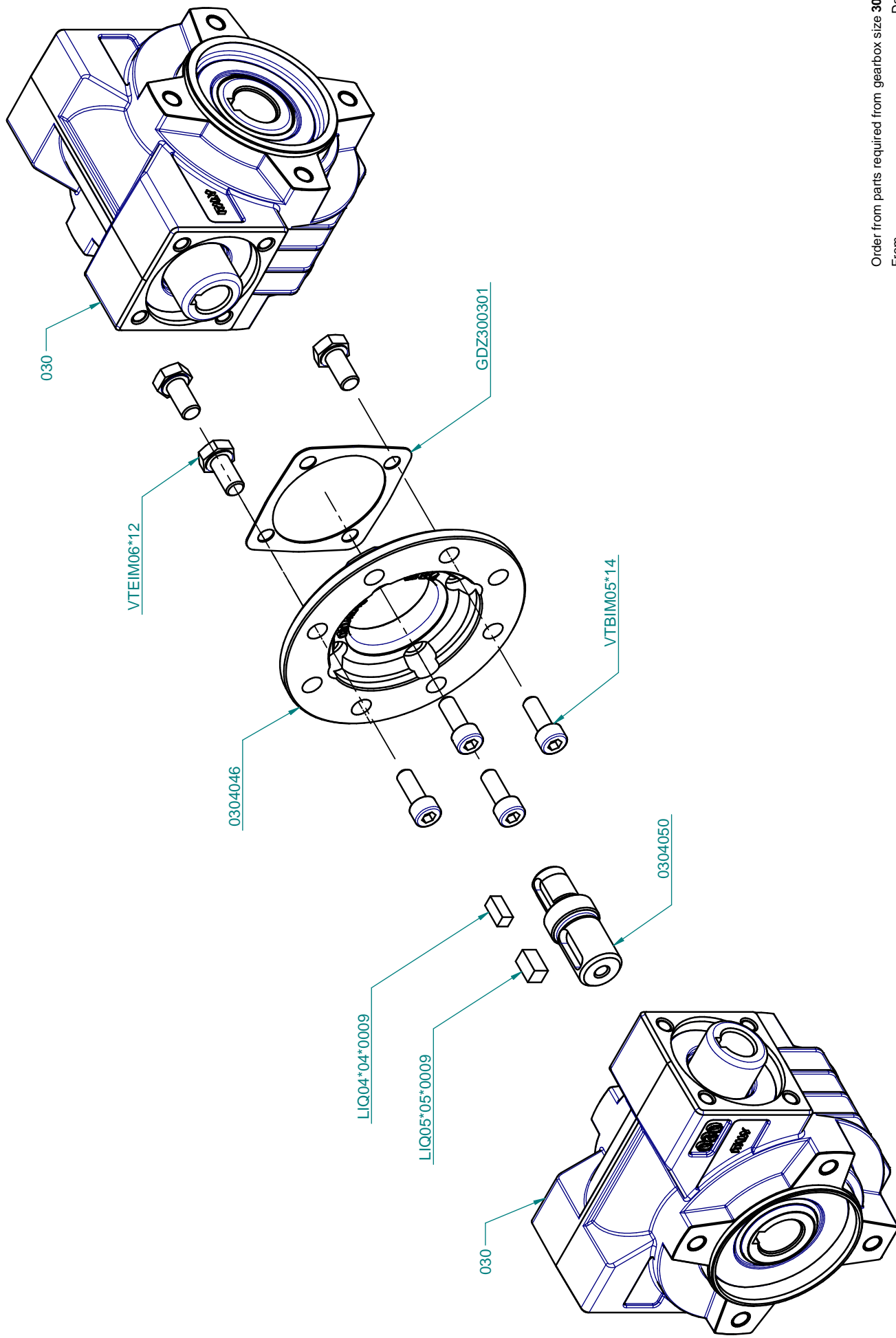

Order from parts required from gearbox size 303 ratio _____

From _____ Date ____/____/____

Parts	Qty	Description

Fax: +39 0444 536139 ---- e-mail: hydromec@hydromec.com

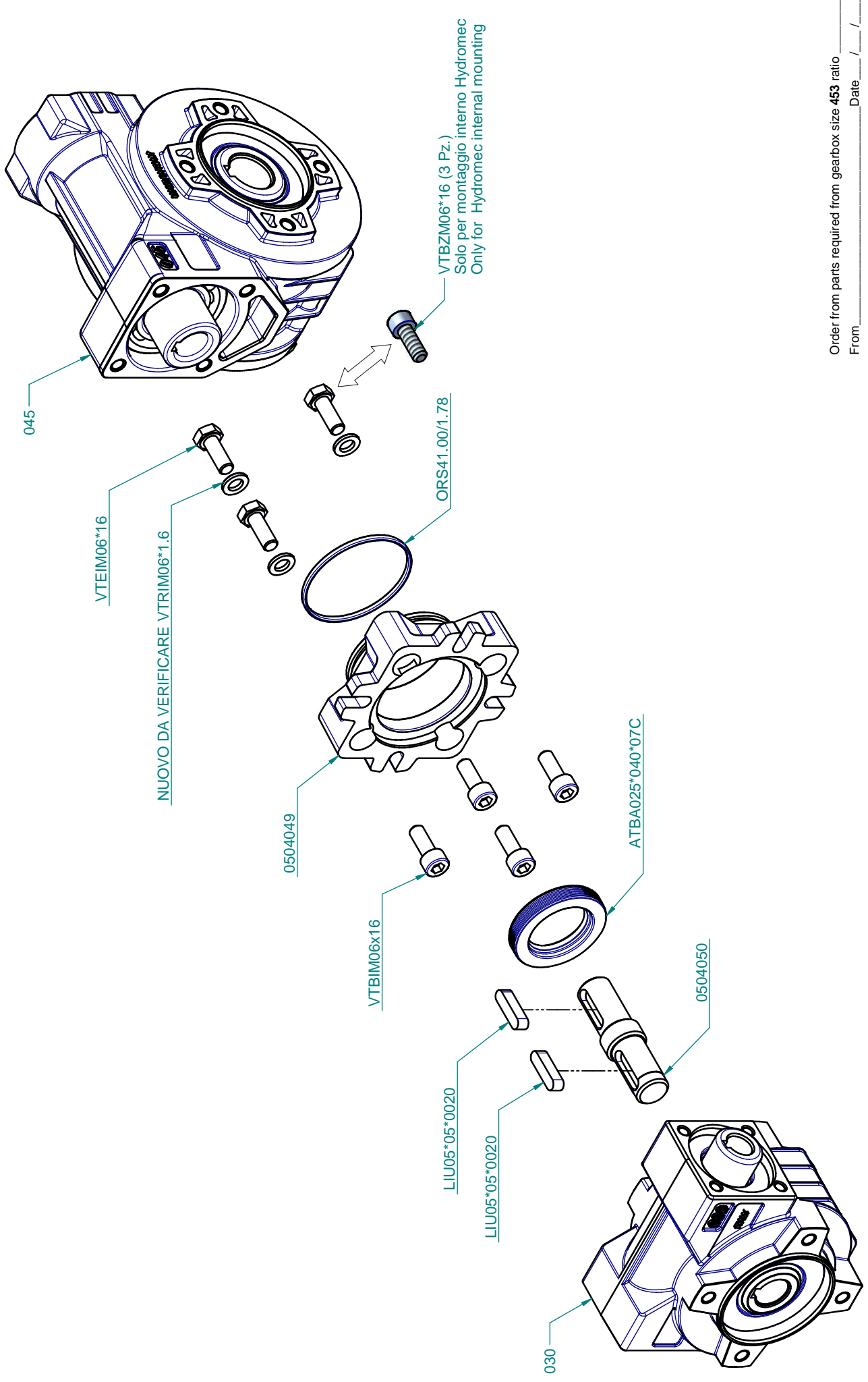

Order from parts required from gearbox size **453** ratio _____
From _____ Date ____/____/____

Parts	Q.ty	Description

Fax: +39 0444 536139 ---- e-mail: hydromec@hydromec.com

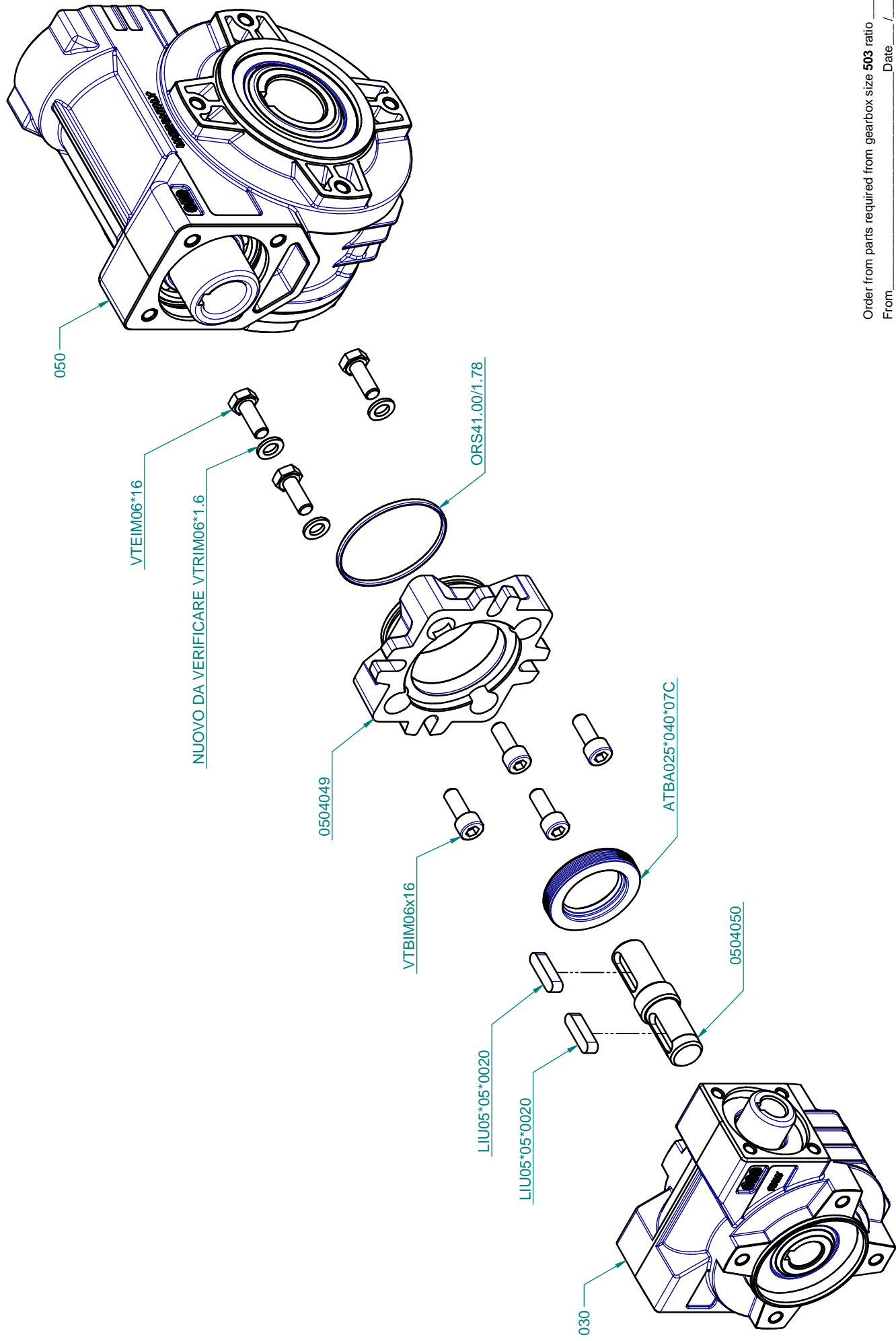

Order from parts required from gearbox size **503** ratio _____

From _____ Date _____ / _____ / _____

Parts	Q.ty	Description

Fax: +39 0444 536139 ---- e-mail: hydromec@hydromec.com

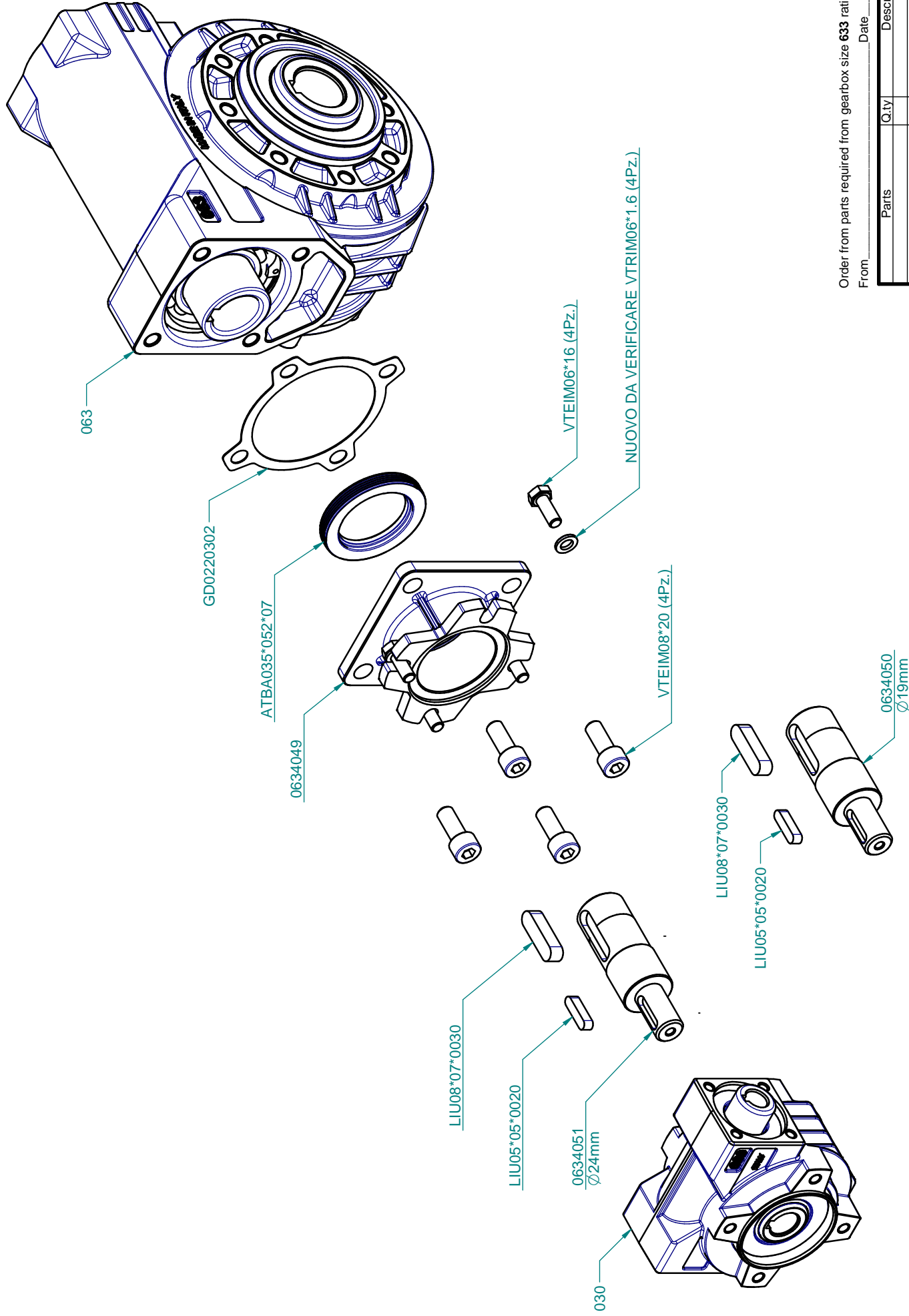

Order from parts required from gearbox size **633** ratio _____

From _____ Date ____/____/____

Parts	Q.ty	Description

Fax: +39 0444 536139 ---- e-mail: hydromec@hydromec.com

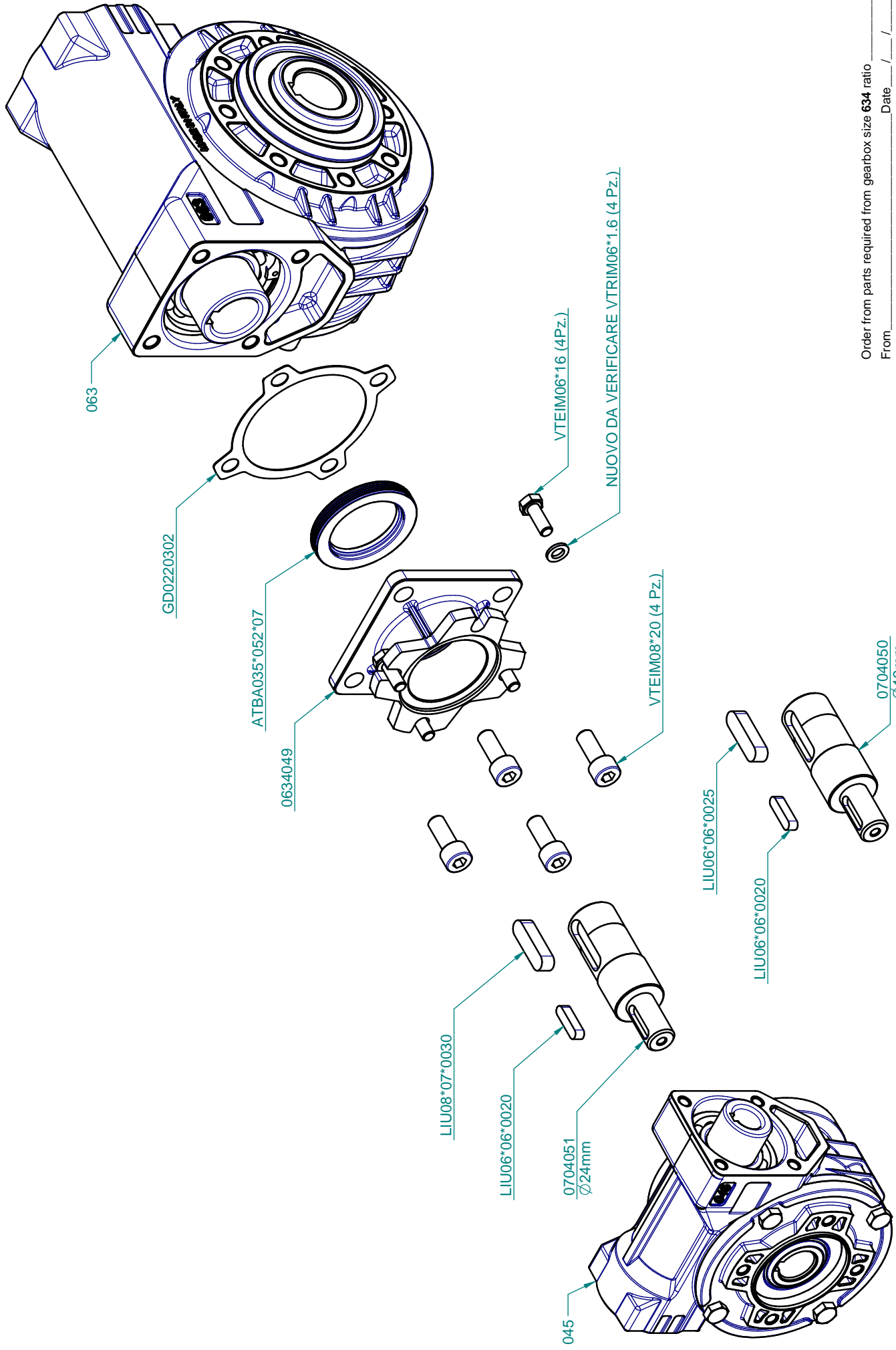

Order from parts required from gearbox size 634 ratio _____

From _____ Date ____/____/____

Parts	Q.ty	Description

Fax: +39 0444 536139 ---- e-mail: hydromec@hydromec.com

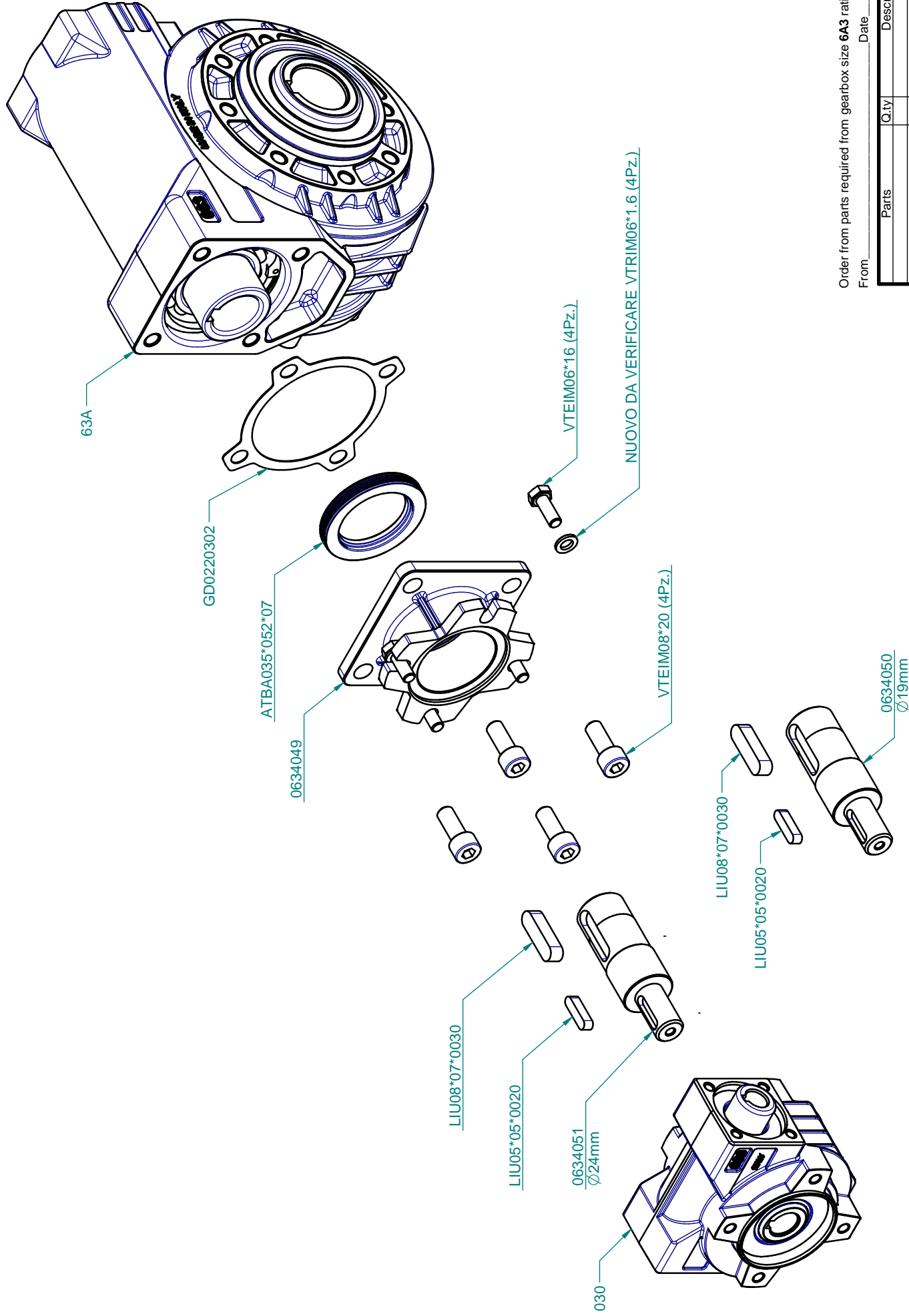

Order from parts required from gearbox size **6A3** ratio _____

From _____ Date ____/____/____

Parts	Q.ty	Description

Fax: +39 0444 536139 ---- e-mail: hydromec@hydromec.com

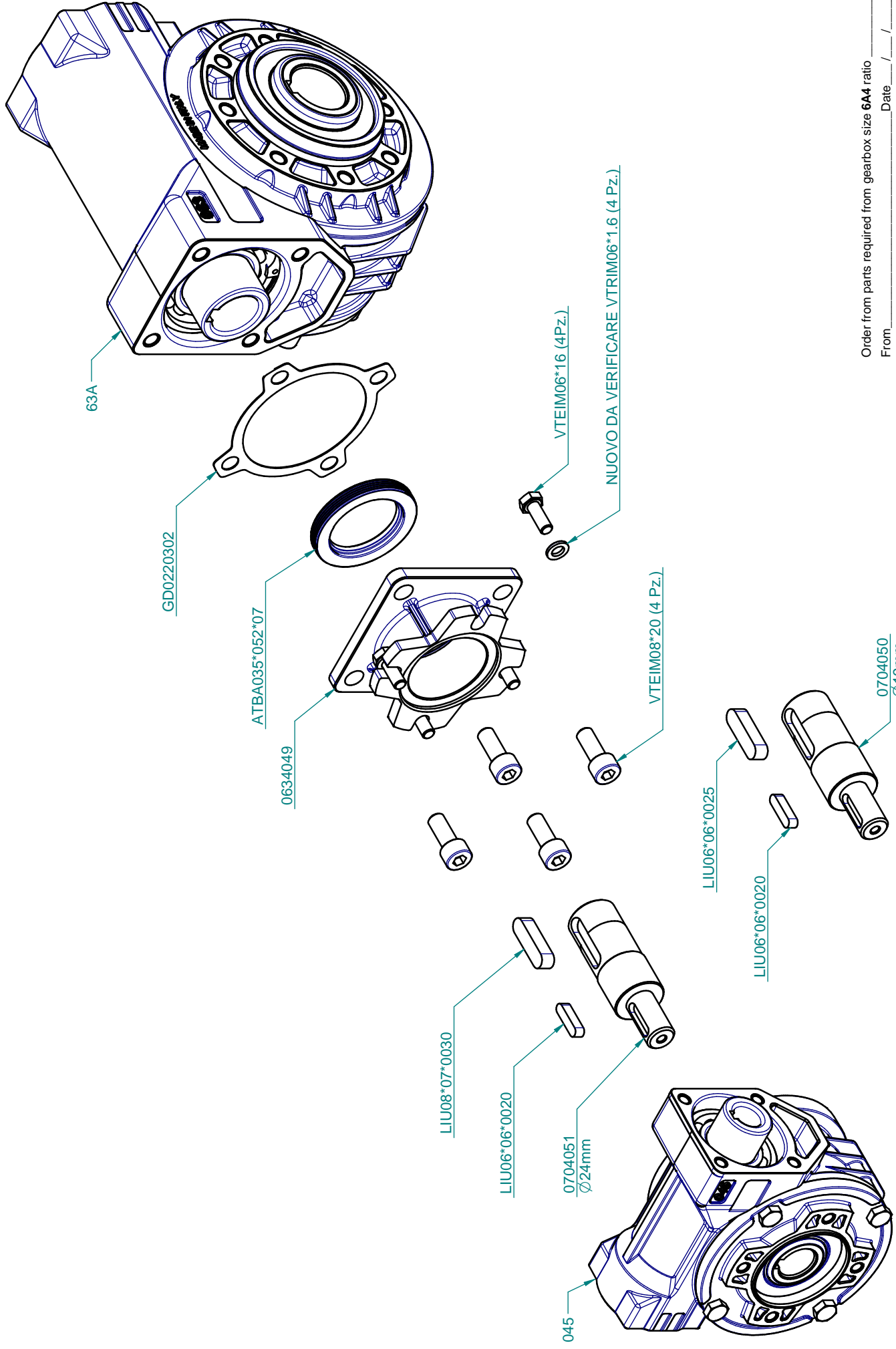

Order from parts required from gearbox size **6A4** ratio _____

From _____ Date ____/____/____

Parts	Q.ty	Description

Fax: +39 0444 536139 ---- e-mail: hydromec@hydromec.com

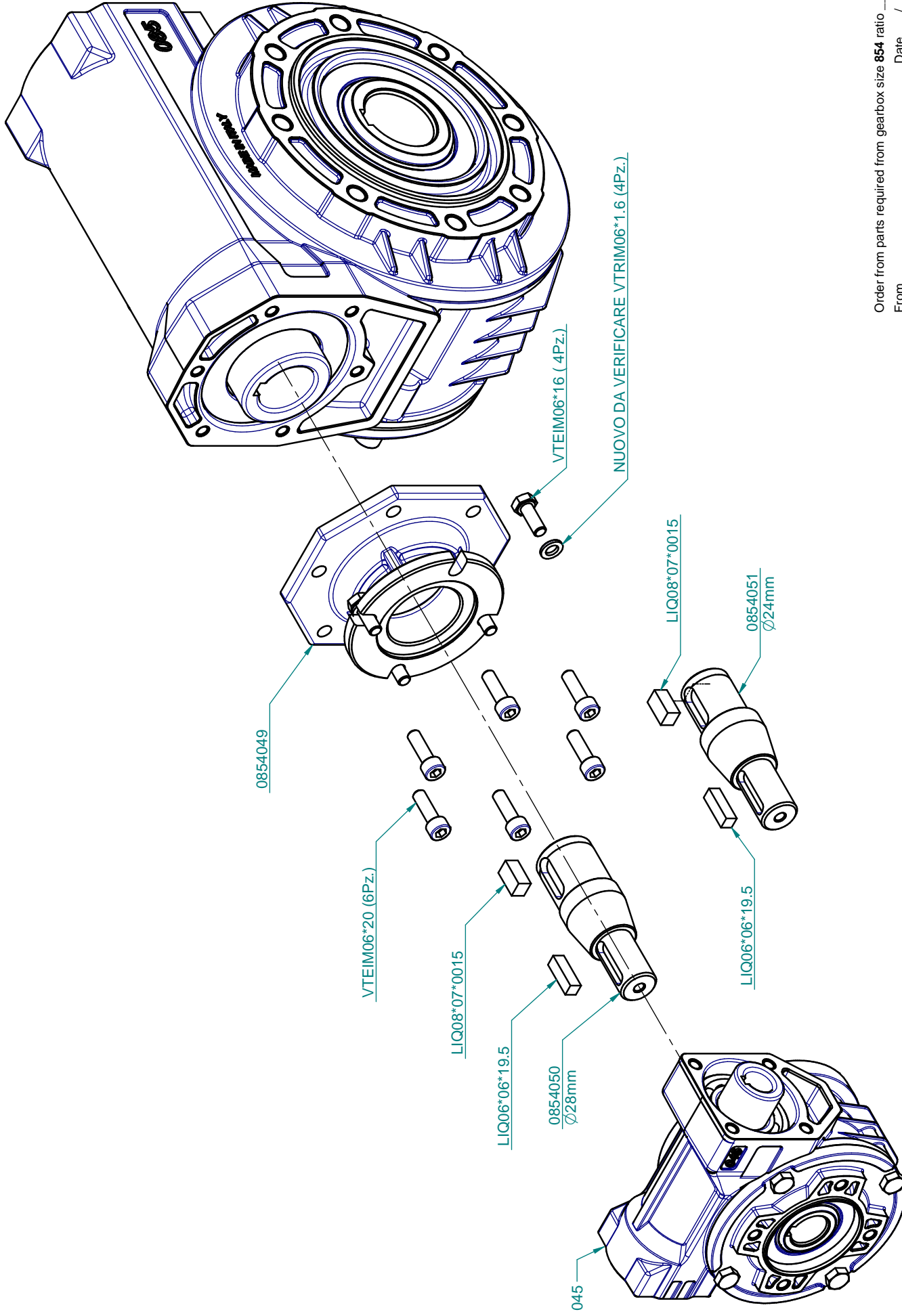

Order from parts required from gearbox size **854** ratio _____

From _____ Date ____/____/____

Parts	Qty	Description

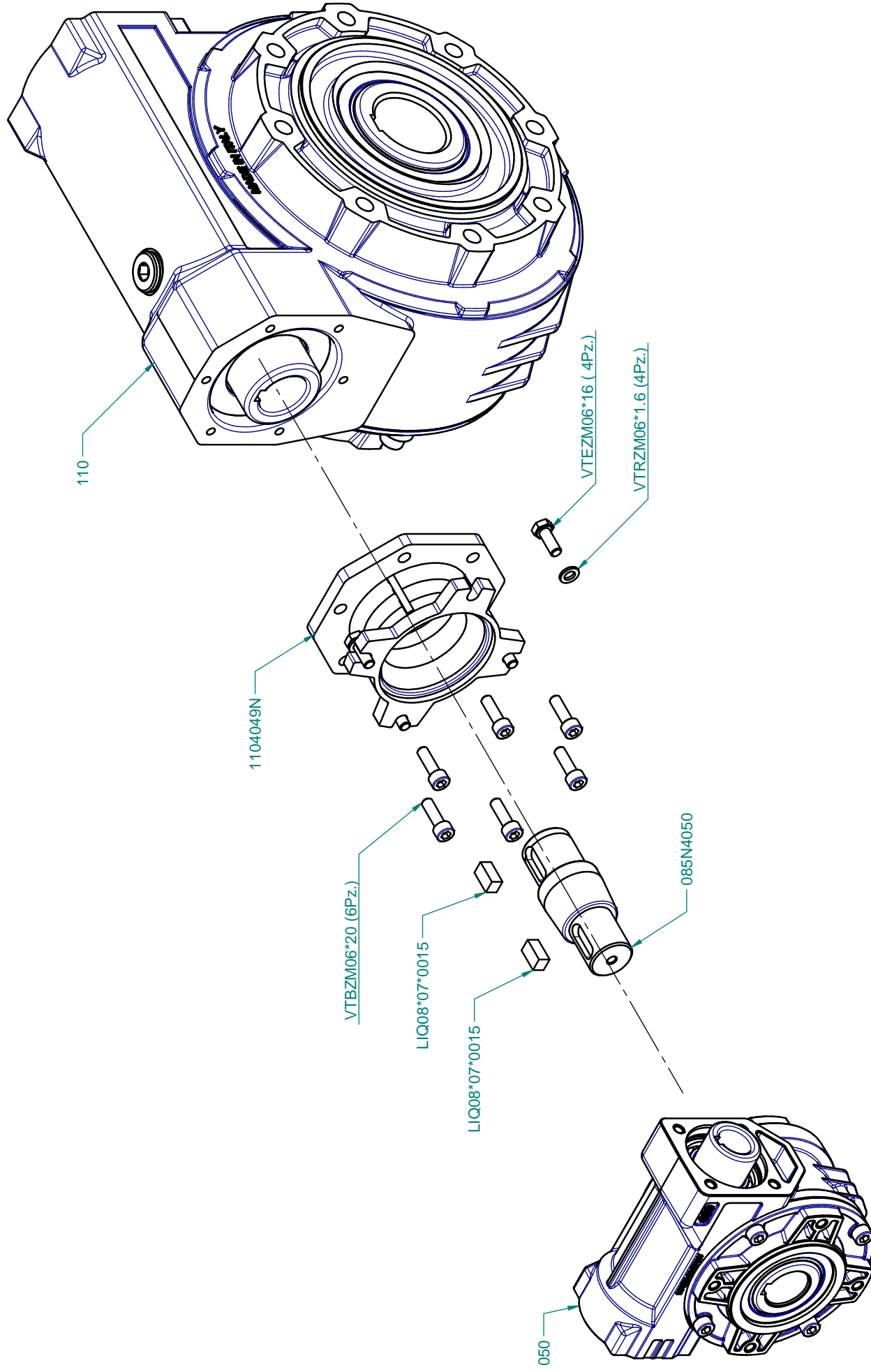

Order from parts required from gearbox size 115 ratio _____

From _____ Date ____/____/____

Parts	Qty	Description

Fax: +39 0444 536139 ---- e-mail: hydromec@hydromec.com

HYDRO-MEC

www.hydromec.com

Distributed from

