

QUICK SELECTION / Selezione veloce

input speed (n_1) = 1400 min⁻¹

	Output Speed n_2 [min ⁻¹]	Ratio i	Motor power P_{1M} [kW]	Output torque M_{2M} [Nm]	Service factor f.s.	Nominal power P_{1R} [kW]	Nominal torque M_{2R} [Nm]	Available B5 motor flanges				Available B14 motor flanges				Dynamic efficiency RD	Tooth Module [mm]	Ratios code
								-B	-C	-D	-E	-P	-Q	-R	-T			
								63	71	80	90	63	71	80	90			
IEC 90 - 80 - 71	47	29.9	0.75	113	1.5	1.1	165						C	C		74	2.6	01
	37	37.7	0.75	141	1.2	0.88	165						C	C		73	2.0	02
	30	47.1	0.75	169	1.1	0.83	187						C	C		70	3.2	03
	25	56.6	0.55	136	1.4	0.76	187						C	C		64	2.7	04
	19.8	70.7	0.55	164	1.1	0.63	187						C	C		62	2.1	05
	15.9	87.8	0.37	162	1.2	0.43	187						C	C		73	2.6	06
	12.6	111.0	0.37	199	0.9	0.35	187						C	C		71	2.0	07
IEC 71 - 63	10.1	139	0.37	234	0.8	0.30	187						C			67	3.2	08
	8.4	166	0.25	173	1.1	0.27	187						C			61	2.7	09
	6.7	208	0.18	151	1.1	0.20	165						C			59	2.1	10
	4.5	310	0.12	129	1.3	0.15	165						C			51	1.5	11
	3.8	370	0.12	145	1.1	0.14	165						C			48	1.3	12
	3.2	434	0.12	149	0.9	0.11	138						C			42	1.1	13

Motor Flanges Available Flange Motore Disponibili
 B) Supplied with Reduction Bushing Fornito con Bussola di Riduzione
 B) Available on Request without reduction bushing Disponibile a Richiesta senza Bussola di Riduzione
 C) Motor Flange Holes Position Posizione Fori Flangia Motore

EN Unit **P63** is supplied with synthetic oil, providing "long life" lubrication. For mounting position V5-V6 please contact us. See table 1 for lubrication and recommended quantity. In table 2 please see possible radial loads and axial loads on the gearbox.

I Il riduttore tipo **P63** viene fornito lubrificato a vita con olio sintetico. Per posizioni V5-V6 contattare il ns. servizio tecnico. Vedi tab.1 per oli e quantità consigliati. In tab.2 sono presenti i carichi radiali e assiali applicabili al riduttore.

D Für die Lebensdauerschmierung ist das Getriebe der Größe **P63** mit synthetischem Öl befüllt. Bei Einbaulage V5 oder V6 bitten wir um Rücksprache. In Tabelle 1 ist die Schmiermenge und das empfohlene Schmiermittel angegeben. In Tabelle 2 sind die zulässigen Radial- und Axialbelastungen des Getriebes aufgeführt.

F Le réducteur de type **P63** est fourni lubrifié à vie avec de l'huile synthétique. Concernant les positions V5.V6, contactez notre service d'assistance technique. Voir tableau 1 concernant les huiles et les quantités conseillées. Les charges radiales et axiales applicables au réducteur sont précisées dans le tableau 2.

E El reductor tamaño **P63** se suministra, lubricado de por vida con aceite sintético. Para las posiciones V5 y V6 contactar con nuestro servicio técnico. Ver tabla 1, para cantidades y aceites recomendados. En la tabla 2, se encuentran las cargas radiales y axiales admitidas por el reductor.

LUBRICATION P63 Oil

For B3-V5-V6 separate lubrication for A (0.40 l) B (0.08 l), for B6-B7-B8 common lubrication 0.38 l (A + B).

AGIP Telium VSF 320
 SHELL Omala S4 WE 320

For all details on lubrication and plugs check our website **tab. 1**
Per maggiori dettagli su lubrificazione e tappi olio vedi il nostro sito web

RADIAL AND AXIAL LOADS

Output shaft
Albero di uscita

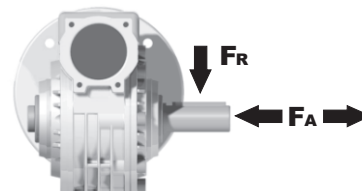

n_2 [min ⁻¹]	FA [N]	FR [N]
75	500	2500
50	600	3000
25	700	3800
15-6	800	4000

Input shaft
albero in entrata

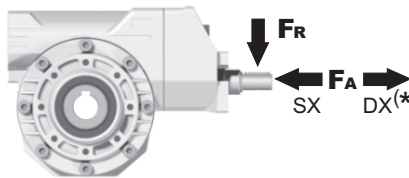

n_1 [min ⁻¹]	FA [N]	FR [N]
1400	61	305

***Strong axial loads in the DX direction are not allowed.**
Non sono consentiti forti carichi assiali con direzione DX

tab. 2

PP63**FB**... Basic wormbox
Riduttore base

Gearbox weight	29.9+111	139+434
peso riduttore	7.30 Kg	7.80 Kg

M.flange	Kit code	øF	A
71B5	K063.4.042	160	176.5
80/90B5	K063.4.043	200	178.5
71B14	K063.4.047	105	176.5
80B14	K063.4.046	120	178.5
90B14	K063.4.041	140	178.5
139+434			
63B5	K050.4.041	138	162.5
71B5	K050.4.042	160	160
63B14	K050.4.047	90	162.5
71B14	K050.4.045	105	160

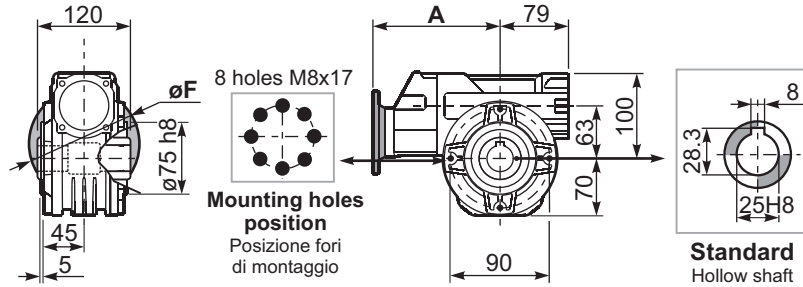

PP63**PA**... Feet
Piedini

PP63**PB**... Feet
Piedini

PP63**PV**... Feet
Piedini

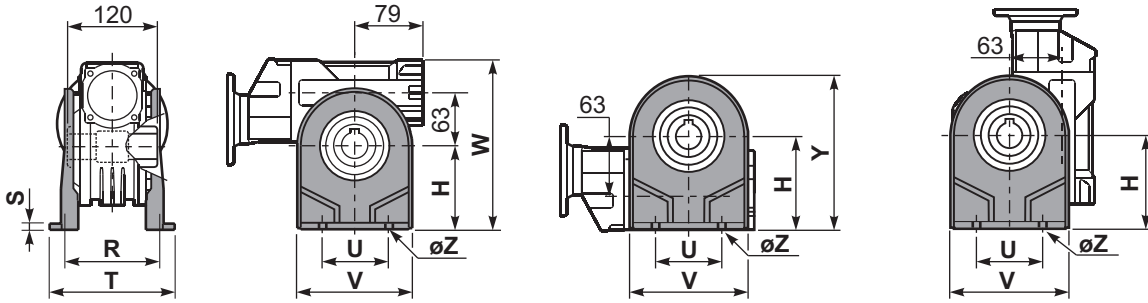

	H	R	S	T	U	V	Y	W	øZ	kit code
type B	100	111	4	144	95	133	170	200	ø10.5	K063.9.022
type S	-	-	-	-	-	-	-	-	-	-

PP63**FC**... Output flange
Flangia uscita

PP63**BR**... Reaction arm
Braccio di reazione

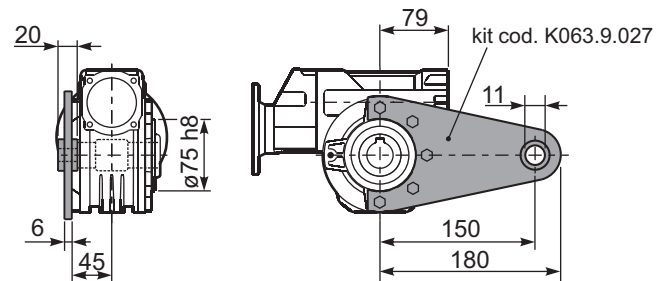
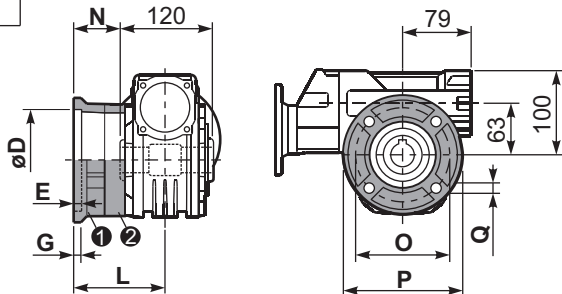

type B	øD	E	G	L	N	O	P	Q	kit code
FC	115 ^{+0.20} / _{+0.15}	7	13	86	26	150	175	11	① K063.9.010 ② -
FL	115 ^{+0.20} / _{+0.15}	7	13	116	56	150	175	11	① K063.9.010 ② K063.0.200
type S	øD	E	G	L	N	O	P	Q	kit code
F1	130 ^{+0.20} / _{+0.15}	7	13	102	42	165	200	13	① KS070.9.013 ② -
F2	115 ^{+0.20} / _{+0.15}	7	13	116	56	150	175	11	① KS063.9.013 ② -
F3	110 ^{+0.035} / ₀	5	11	82	22	130	160	10	① KS063.9.011 ② -

PP63.....**S**... Single Shaft
Albero lento semplice

PP63.....**D**... Double Shaft
Albero lento bisp.

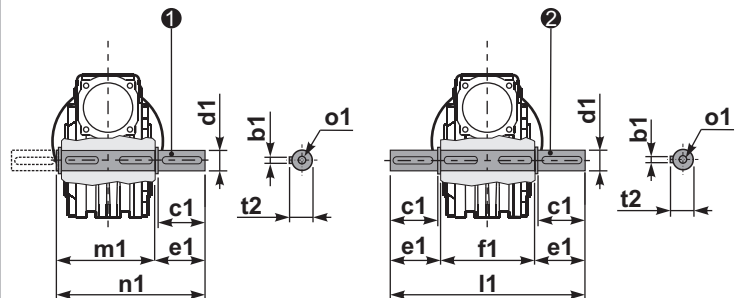

① kit cod. K063.5.028 type B ② kit cod. K063.5.029 type B

RP63**FB**... Input shaft
Albero in entrata

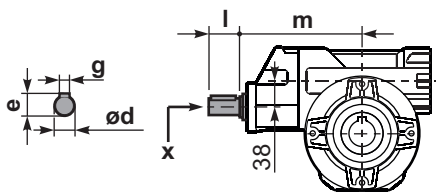

	ød	e	g	l	m	x	
29.9+111	19 h6	21.5	6	35	169.4	M6x16	C40.5.062
139+434	14 h6	16	5	25	154.2	M5x13	C35.5.061

	b1	c1	d1	e1	f1	l1	m1	n1	t2	o1
type B	8	60	25 ^{-0.005} / _{-0.020}	63.2	120	246.4	126.8	190	28	M8x20
type S	-	-	-	-	-	-	-	-	-	-